

VIRGINIA POLYTECHNIC INSTITUTE
LIBRARY
BLACKSBURG, VIRGINIA

Interlibrary
Loan

age

THE UNITED STATES
STRATEGIC BOMBING SURVEY

UNDERGROUND
AND DISPERSAL PLANTS IN



Virginia Tech Interlibrary Loan

ILLiad TN: 1276459 

Title Underground and dispersal plants in greater
Germany /
Author
Call # Docs W1.71:UN2 Remote Storage Building
Lending String
*VPI,VMI,VIC,VLW,NDD,MUM,LUU,EMU,KEN,FDA,F
UG,AZS,UMK,CSA,ORZ
Patron
Due 8/13/2015 NO RENEWALS

ILL# 149854126 

SHIP UPS
Loaned To: VA@- ILL-Borrowing

Email: ill@vt.edu **Phone:** (540) 231-6344
<http://www.lib.vt.edu/ill/>

OIL DIVISION
JANUARY 1947

THE UNITED STATES
STRATEGIC BOMBING SURVEY

UNDERGROUND
AND DISPERSAL PLANTS IN
GREATER GERMANY

OIL DIVISION

Date of Survey:

21 August 1945

First Edition 23 October 1945

Second Edition January 1947

This report was written primarily for the use of the U. S. Strategic Bombing Survey in the preparation of further reports of a more comprehensive nature. Any conclusions or opinions expressed in this report must be considered as limited to the specific material covered and as subject to further interpretation in the light of further studies conducted by the Survey.

This edition has been reproduced by a photolithographic offset process from the first edition of the report. To expedite, standardize and clarify the printing of this and other European reports, minor changes have been made on the cover, title page and some drawings.

Foreword

The United States Strategic Bombing Survey was established by the Secretary of War on 3 November 1944, pursuant to a directive from the late President Roosevelt.

The officers of the Survey were:

Franklin D'Olier, Chairman.
Henry C. Alexander, Vice-Chairman.

George W. Ball,
Harry L. Bowman,
John K. Galbraith,
Rensis Likert,
Frank A. McNamee, Jr.,
Paul H. Nitze,
Robert P. Russell,
Fred Searls, Jr.,
Theodore P. Wright, Directors.

Charles C. Cabot, Secretary.

The Table of Organization provided for 300 civilians, 350 officers and 500 enlisted men. The Survey operated from headquarters in London and established forward headquarters and regional headquarters in Germany immediately following the advance of the Allied armies.

It made a close examination and inspection of several hundred German plants, cities and areas, amassed volumes of statistical and documentary material, including top German government documents; and conducted interviews and interrogations of thousands of Germans, including virtually all of the surviving political and military leaders. Germany was scoured for its war records which were found

sometimes, but rarely, in places where they ought to have been; sometimes in safe-deposit vaults, often in private houses, in barns, in caves; on one occasion, in a hen house and, on two occasions, in coffins. Targets in Russian-held territory were not available to the Survey.

Some two hundred detailed reports were made. During the course of its work, the Survey rendered interim reports and submitted studies and suggestions in connection with the air operations against Japan.

While the European War was going on, it was necessary, in many cases, to follow closely behind the front; otherwise, vital records might have been irretrievably lost. Survey personnel suffered several casualties, including four killed.

The Survey studied the effects of the air attack on Japan and further reports have been submitted to the Secretary of War and the Secretary of the Navy.

TABLE OF CONTENTS

| | Page |
|--|------|
| Summary | 1 |
| Tabulation of Underground and Dispersal Plants | 5 |
| Introduction | 8 |
| Aviation Fuels | 11 |
| SCHWALBE - Hydrogenation | 11 |
| KUCKUCK - Combination Aviation Fuels | 12 |
| KYBOL - Di-ethyl-benzene | 13 |
| ILTIS - Superfractionation | 15 |
| KRANICH - Catalytic Cracking | 15 |
| KLEIN SCHOLVEN - Hydrogenation | 15 |
| Motor Gasoline | 23 |
| OFEN - Dispersed Crude Unit | 23 |
| ROST - Primitive Crude Unit | 23 |
| TAUBE - Cracking Plant | 23 |
| KARPFEN - Small Fischer Plants | 27 |
| JAKOB - Primitive Cracking Plant | 27 |
| KUGELOFEN - Cracking Plant | 27 |
| Lubricating Oil | 34 |
| DACHS - Lubricating Oil Plants | 34 |
| STEINBOCK - Paraffin | 35 |
| Diesel Fuel | 46 |
| MOLCH - Phenol Extraction | 46 |
| WUESTE - Shale Oil Plants | 46 |
| Miscellaneous Plants | 52 |
| KLEIN SCHOLVEN - Hydrogenation | 52 |
| KUGELOFEN - Cracking | 52 |
| KREBS - Fischer Tropsch | 52 |
| FRITZ - Dewaxing | 52 |
| STEINBOCK - 1 - Catalyst Storage | 52 |
| RABE - Tetra-ethyl-lead | 52 |
| Cost and Manpower | 53 |
| Estimated Costs and Labor Required | 56 |
| The Underground Oil Plant in Practice | 58 |
| Types of Protection | 62 |
| Vault at Muehldorf | 62 |
| Conclusions | 66 |

PART II

PLANT DATA AND DESCRIPTIONS

| | Page |
|--|-----------|
| Basis of Labor Calculations | 67 |
| Glossary of Firm Names and Abbreviations | 69 |
| SCHWALBE - Hydrogenation | 70 - 80 |
| KUCKUCK - Combination Aviation Gasoline | 81 - 91 |
| KYBOL - Di-ethyl-benzene | 92 |
| FASAN - Benzene Alkylation | 95 |
| ILTIS - Superfractionation | 96 |
| KRANICH - Catalytic Cracking | 98 |
| KLEIN SCHOLVEN - Hydrogenation | 99 |
| OFEN - Dispersed Crude Units | 101 - 105 |
| ROST - Primitive Crude Units | 106 - 108 |
| TAUBE - Cracking | 109 - 113 |
| KARPFEN - Fischer Tropsch | 114 - 119 |
| JAKOB - Primitive Cracking | 120 - 130 |
| KUGELOFEN - Cracking Plants | 131 |
| DACHS - Lubricating Oil | 132 - 152 |
| STEINBOCK 2 Parafflow and catalyst | 153 - 160 |
| MOLCH - Phenol Extraction | 161 - 167 |
| WUESTE - Shale Oil | 168 - 171 |
| KREBS - Fischer Tropsch | 172 |
| FRITZ - Dewaxing | 173 |
| STEINBOCK 1 - Catalyst and High Pressure Equipment Repair | 174 |
| RABE - Tetra-ethyl-lead | 176 |

LIST OF FIGURES

| | | Page |
|-----------|---|------|
| Figure 1 | Location of Underground and Dispersal Plants | 7 |
| Figure 2 | Total Production Expected - Underground and Dispersal Program | 10 |
| Figure 3 | KUCKUCK - Flow Diagram | 14 |
| | Little Scholven - Hydrogenation Plant | |
| Figure 4 | Reactors | 16 |
| Figure 5 | Separator | 16 |
| Figure 6 | Distillation Unit | 17 |
| Figure 7 | Distillation Furnace | 17 |
| | Di-ethyl Benzene Plant at Gendörf | |
| Figure 8 | Distillation Equipment | 18 |
| Figure 9 | Catalyst Chambers | 18 |
| Figure 10 | Hydrogenation Plants - Underground and Dispersal | 19 |
| Figure 11 | Planned Capacity-Aviation Gasoline | 22 |
| Figure 12 | Typical 'OFEN' Installation-Small Topping Unit | 24 |
| | Cracking Plant at Deggendorf | |
| Figure 13 | Fractionators | 18 |
| Figure 14 | Furnace | 18 |
| Figure 15 | Pump House | 18 |
| Figure 16 | Tank Field | 18 |
| | Fischer Tropsch Plant at Leipzig | |
| Figure 17 | General View | 28 |
| Figure 18 | Rear View of Ovens | 28 |
| Figure 19 | Close up of Fischer Oven | 28 |
| Figure 20 | Treating Section | 28 |
| Figure 21 | Planned Capacity-Motor Gasoline | 32 |
| Figure 22 | Processing of Brown Coal Tar | 33 |
| Figure 23 | Underground Lubricating Oil Plant - Porta-Schematic Drawing | 36 |
| | Underground Lubricating Oil Plant at Porta | |
| Figure 24 | Furnace - Furfural Unit | 37 |
| Figure 25 | Main Entrance | 37 |
| Figure 26 | Separators-Furfural Unit | 37 |
| Figure 27 | Vacuum Pumps - Furfural Unit | 38 |
| Figure 28 | Distillation Columns | 38 |
| Figure 29 | Separators and Extraction Columns | 39 |
| Figure 30 | Chillers - Dewaxing Unit | 39 |
| Figure 31 | Ammonia Compressors - Dewaxing Unit | 39 |
| Figure 32 | Dewaxing Unit Filters | 40 |
| Figure 33 | Filter Mechanism - Dewaxing Unit | 40 |

LIST OF FIGURES
(Continued)

| | | Page |
|----------------------------------|-------------------------------------|------|
| Figure 34 | Boiler Plant | 41 |
| Figure 35 | Feed Tanks | 41 |
| Figure 36 | Planned Capacity-Lubricating Oils | 44 |
| Figure 37 | Unit Plan for Petroleum Processing | 45 |
| Dephenolizing Plant at Altenburg | | |
| Figure 38 | General View | 64 |
| Figure 39 | Receivers | 64 |
| Figure 40 | Schematic Layout of Shale Oil Plant | 49 |
| Figure 41 | Planned Capacity - Diesel Oil | 51 |
| Concrete Vault at Muehldorf | | |
| Figure 42 | End View | 64 |
| Figure 43 | Side View | 64 |

LIST OF FIGURES-APPENDIX

| | | Page |
|-----------|---|------|
| Figure 44 | Hydrogenation Unit | 72 |
| Figure 45 | Underground Plants at Niedersachswerfen | 83 |
| Figure 46 | Catalytic Cracking Unit | 85 |
| Figure 47 | Hydroformer DHD | 88 |
| Figure 48 | Alkylation and Butane Dehydrogenation | 91 |
| Figure 49 | Di-ethyl Benzene Plant | 93 |
| Figure 50 | ''OFEN'' - Small Topping Unit | 104 |
| Figure 51 | Flow Diagram ''ROST'' | 197 |
| Figure 52 | ''TAUBE'' - Cracking Plant | 111 |
| Figure 53 | ''KARPFEN'' - Fischer Tropsch Plant | 116 |
| Figure 54 | Karpfen Plants - Capacities | 118 |
| Figure 55 | ''DACHS 1'' - Flow Diagram | 134 |
| Figure 56 | Edeleanu Dewaxing | 138 |
| Figure 57 | Sulfuric Acid Treating | 138 |
| Figure 58 | Suida - Nobel - Poell Dewaxing | 142 |
| Figure 59 | Barisol Dewaxing | 143 |
| Figure 60 | Lubricating Oil synthesis | 146 |
| Figure 61 | Underground Refinery Dachs IV | 147 |
| Figure 62 | Schematic View - Steinbock II | 160 |

SUMMARY

The heavy attacks on strategic oil targets in May 1944 showed the Germans that they could not repair their big plants as fast as Allied bombers could wreck them. So they made plans in June to spread many small plants throughout Germany and to put a number of them underground.

Several German technical men say now that they had proposed that production be moved underground as early as 1940. But, they were told that the war would be won before the plants could be built, and they were threatened with confinement in concentration camps for questioning the Reich's impregnability. The suggestion, nevertheless, was feasible. Properly designed and ventilated oil plants could be operated underground with reasonable safety. Inspecting and maintaining properly built underground plants would have been much less difficult and dangerous than repairing and running surface plants subjected to bombing periodically--but the Germans formulated their plans and began to dig too late.

On May 31, 1944, Albert Speer, Reichsminister for Armament and War Production, chose Edmund Geilenberg as General Commissioner for Immediate Measures, and the underground and dispersal program that was adopted a few weeks later was entrusted to him. Geilenberg was a former miner who had become manager of the Brunswick Steel Works. He was given unlimited authority to take labor and materials from other industries, and at one time he commanded a labor force of 350,000 persons. "He is responsible", Hitler had decreed, "for tackling the work turned over to him with a generous supply of manpower and material and reckless energy. The speed of the work is not to be impaired either by formal or regional obstacles".

The underground and dispersal program, as originally formulated, was expected to supply Germany with 82 per cent as much aviation gasoline as had been produced in January 1944, 25 per cent as much motor gasoline, half as much lubricating oil of all types, two-thirds as much aviation lubricating oil, and 88 per cent as much diesel oil. But, despite Geilenberg's prodigious efforts, only about a million barrels of straight-run gasoline and diesel oil and a small amount of a blending agent were obtained up to the end of the war.

Aviation Fuel The program called for production of 130,000 tons of aviation fuel per month (37,000 bbl. per day), beginning in the summer of 1945, but none of the aviation-fuel plants could have started until late that Fall.

Seven high-pressure catalytic hydrogenation plants were to have been built underground and one above ground, to produce 92,000 tons

of aviation gasoline and jet plane fuel per month. Six were to be fed tar from coal-carbonization plants, and two were to be fed gas oil and residuum from crude. Only two of these plants were still under construction when the war ended, and work on the others had been dropped previously.

A more complicated underground plant, to produce 19,400 tons of aviation fuel per month, was planned at Niedersachswerfen. This was to have been built in a gypsum cliff alongside an underground V-1 and V-2 factory, a Junkers aircraft plant and a liquid-oxygen plant. The installation was to have included two vapor-phase hydrogenation units operating in series, and a catalytic cracking unit to convert coal tar and crude oil distillate into aviation gasoline; a hydro-forming unit to increase the octane number and aromatically of straight-run and hydrogenated gasoline, and an alkylation and butane dehydrogenation unit to produce iso-octane. When Germany surrendered, however, the tunnels for this plant were only three-fifths completed, and only a small amount of the equipment had arrived at the site.

The aviation-fuel program also included several small plants and five units to produce blending agents. One of the latter, capable of producing 1,400 tons of di-ethyl-benzene per month, began operating in January 1945. Other aviation-fuel plants were under construction, but not finished, when Germany collapsed.

Motor Gasoline The motor gasoline program was expected to produce 41,000 tons per month (12,000 bbl. per day), of which about one-fourth was to be fed to the aviation gasoline plants. Forty-one dispersed plants were completed, which could have handled all of the crude oil produced in Germany, but less than 40 per cent of their capacity was used, mainly because of transportation troubles.

To produce motor gasoline from crude oil, the Germans planned forty small distillation units in the hills, in the woods, in quarries, and sometimes underground. Thirty-six of these were in operation in the Fall of 1944. These dispersed plants were camouflaged and too small and widely scattered to be attractive targets for bombers. They were completed in four months and each one had a crude capacity conservatively estimated at 3,000 tons per month. In addition, five primitive distillation units were built in bombed-out industrial plants, where they were camouflaged by the wreckage. These were continuous shell stills built from boilers and salvaged equipment.

Tar from the dispersed crude distillation units was to have been used as feed for the lubricating oil plants, but destruction of the latter forced them to store it in open pits. Two modern thermal cracking units were being built to use this tar to produce gasoline, diesel and fuel oils. These units were removed from damaged refineries to sites protected by cliffs or woods.

Destruction of hydrogenation plants also left the Germans with an excess of tar from coal-carbonization, so they planned 33 small, primitive, cracking units to make use of it. Construction of these plants, however, was not very far along.

In addition they started to build ten small Fischer-Tropsch plants above ground, to make motor gasoline out of carbon monoxide and hydrogen from city gas works.

Lubricating Oil There are several operating steps in the production of lubricating oil, and considerable storage of intermediate products is necessary. Hence, dispersal of these plants was not considered feasible, and plans were made to go underground. Six were to be built underground, and two were to be concealed in woods and valleys. These plants were to have been quite complete, and were to have produced 38,000 tons per month of lubricating oil of which 6,000 tons would have been aviation grade. All grades, from light machine oils through heavy cylinder oils and waxes, were to be produced.

More progress was made on these plants than on other parts of the underground program. If the war had continued, and transportation had been available, the Germans probably would have been fairly well supplied with lubricants in the Fall of 1945.

Diesel Oil Diesel oil was to be produced largely as a by-product, but two types of plants were designed expressly for production of this fuel. Six plants were being built to remove phenols from the middle oil produced in coal-carbonization plants, thereby making it suitable for diesel oil and recovering the phenols for use in the chemical industry. In addition, ten primitive units for the extraction of oil from shale were planned and makeshift operations were started in some of them. The shale was piled about 10 feet high, covered with a layer of peat, and ignited. Air was then drawn through this mass and the combustion which occurred produced enough heat to crack oil vapors out of the shale. These vapors were condensed to produce a very low grade of diesel fuel, usable only in hot bulb (semi-diesel) engines. All told, the Germans expected to get 38,000 tons of diesel oil per month from their phenol-extraction and shale-oil plants. This and by-products from other operations would have given them 159,000 tons per month, but the diesel oil required to feed cracking units and a hydrogenation plant would have reduced the output to 103,000 tons per month.

In addition to these projects which were part of an integrated program, several small plants were planned to take advantage of local situations. Three were to be built, for instance, with equipment salvaged from the Schölvén hydrogenation plant after it was bombed, another was to be a small Fischer-Tropsch plant with 20 ovens in the face of a cliff, and another was to be a dewaxing unit for lubricating oil in the basement of a brewery.

The whole program called for about 140 separate plants, varying greatly in size and type, was to cost 1,400,000,000 RM and would have required at least 200,000 men's labor for a full year.

The scarcity of labor and materials, the loss of construction sites to the advancing Allies, and changing conditions compelled the Germans to revise their plans repeatedly. The program, in fact, was cut in half in the last few months of the war.

Prof. Krauch, Commissioner General for problems of the Chemical Industry, estimated that it was three times as costly to put plants underground as to build them on the surface. Dr. Fritz Ringer, head of the Mineral Oil Bureau under Dr. Bueteffisch, said the program could not have been completed in time for World War II, and Geilenberg himself said he had told Goering in October 1944 that the oil industry could not be saved unless enough fighters were put in the air to protect the refineries above ground.

The most serious weakness in the underground and dispersal program was the reliance on railroad transportation. Most of the plants depended on the railroads both for their raw materials and distribution of their products. This contributed to the overloading of the railroads, which were already severely damaged by aerial attacks. The vulnerability of the transportation facilities was so great that many responsible Germans admitted that strategic bombing could have paralyzed the industry even if the underground and dispersal program had been completed.

The sources of feed for aviation-fuel plants, furthermore, would still have been vulnerable if these plants had been put into operation, because no steps had been taken to protect the carbonization or coal hydrogenation plants on which the underground plants relied for their feed.

Centralized underground plants would have been less vulnerable than the dispersed plants built by the Germans. This would have involved two or three large underground refineries, near the German oil fields in the Hannover and the Danube areas. In addition, several large underground coal hydrogenation and carbonization plants would have been needed near the coal deposits. These large refineries could easily be subdivided by splitting them up into separate tunnels so that an accident to one would not affect the others.

This program would necessarily include crude oil pipelines from the fields to the refineries and a network of product lines for distribution. Distances within Germany are not too great and the steel that went into replacement of bomb damage probably would have been sufficient to cover the pipe lines required.

With this type of program the Germans might have been able to supply their military forces with a respectable quantity of oil products despite strategic bombing.

TABULATION OF UNDERGROUND AND DISPERSED PLANTS

| <u>Code Name</u> | <u>Literal Translation</u> | <u>Type</u> | <u>No. *</u> | <u>Remarks</u> |
|---------------------|----------------------------|---|--------------|----------------------------|
| DACHS | Badger | Lubricating Oil | 8 | Underground |
| FASAN | Pheasant | Benzene alkylation | 2 | Concealed |
| FRITZ | Fritz | Lube oil dewaxing | 1 | Concealed |
| ILTIS | Polecat | Superfractionation | 3 | Concealed |
| JAKOB | Jacob | Cracking | 11 | Concealed |
| KARPFEN | Carp | Small Fischer-Tropsch | 10 | Concealed |
| KLEIN SCHOL- VEN | Little Scholven | Small hydrogenation | 3 | Concealed |
| KRANICH | Crane | Catalytic cracking | 1 | Concealed |
| KREBS | Crawfish | Fischer-Tropsch | 2 | Underground |
| KUCKUCK | Cuckoo | Catalytic cracking Hydrogenation Hydroforming Alkylation | 1 | Underground |
| KUGELOFEN | Ball furnace | Light cracking | 22 | Concealed |
| KYBOL | - - | Di-ethyl-benzene | 3 | Concealed & Underground |
| MOLCH | Salamander | Phenol extraction | 6 | Concealed |
| OFEN | Furnace | Crude distillation | 40 | Concealed |
| ROST | Grill | Primitive crude distillation | 5 | Concealed |

*Figure indicates number of plants planned.

TABULATION OF UNDERGROUND AND DISPERSAL PLANTS - cont'd

| <u>Code Name</u> | <u>Literal Translation</u> | <u>Type</u> | <u>No.</u> | <u>Remarks</u> |
|------------------|----------------------------|----------------------|------------|----------------|
| SCHWALBE | Swallow | Hydrogenation | 6 | Underground |
| STEINBOCK | Goat | Catalyst manufacture | 2 | Underground |
| TAUBE | Dove | Cracking | 2 | Concealed |
| WUESTE | Desert | Shale oil | 10 | Concealed |
| RABE | Crow | Tetraethyllead | 1 | Underground |

*Figure indicates number of plants planned.

UNITS USED IN THIS REPORT

All capacities and production in this report are given in metric tons per month.

- 1 metric ton = 2204 lbs.
- 1 ton of gasoline = Approx 8.6 bbl (42 gallon)
- 1 ton of Diesel oil = Approx 7.3 bbl
- 1 ton of Lube oil = Approx 7.0 bbl

- or 1 ton per month = .287 bbl per day of gasoline
- = .244 bbl per day of Diesel oil
- = .233 bbl per day of Lube oil

In general capacities are based on 25 days operation per month as that was the practice in Germany.





PART I

Introduction

The raids on German refineries and synthetic oil plants during the summer of 1944, caused a serious loss of production, particularly of aviation gasoline. Since the plants were attacked at intervals so short as to limit makeshift production to a few days only, it was decided that drastic measures were required to prevent the ultimate destruction of the German oil industry.

An order from Hitler, dated May 31, 1944, created the position of a General Commissioner for "Immediate Measures", under the Reichsminister for Armament and War Production (the Speer Ministry) who was to speed up the reconstruction of the bombed oil and chemical plants. Reichminister Speer appointed Mr. E. Geilenberg to this position and he was invested by Hitler with almost unlimited powers to requisition labor and material from other industries, if necessary, to accomplish his mission.

Development of Production During 1944:

In May and June, 1944, the Air Force attacks on the German petroleum industry began on a large scale. In some cases the attacks stopped production completely, and in others only partially. As a result of continued air attacks, the situation became more acute and developed into a race between destruction and reconstruction, in which finally reconstruction could not keep pace. In addition, these plants could never be brought to their full original capacity because parts of the plants had been so badly damaged that it was not possible to repair them in any reasonable time. From these badly damaged plants, material which was still usable was removed and used for reconstruction elsewhere.

This reconstruction used up a good part of the reserves of equipment and building materials, as well as equipment on order for new plants, and after a short time it became more difficult to get replacements and the raids had considerably more effect. It was estimated that the repair of the existing plants required as much labor and materials as the continuous building of three large hydrogenation plants.

The first task of the Geilenberg organization was the repair of the damaged hydrogenation plants. One month later, the crude oil refineries were added and within two months the program was expanded to include the nitrogen plants.

At first, the organization functioned solely to repair the damaged plants, in the shortest possible time, but it soon became apparent that the problems arising from air raid damage could not be solved merely by reconstruction. It was necessary to remove plants to safe places or to so disperse them that resulting damage from any one attack would involve only a small part of the production. At this time, about June, 1944, the planning was started which resulted in the underground and dispersal planning of the Fall and Winter of 1944. The Geilenberg organization was given the additional job of dispersing the oil industry to reduce its vulnerability, and to relocate the more important and complex plants underground in such manner that they would be safe from air attack.

The projected underground and dispersal program involved the production of the following amounts of gasoline and oil when completed:

Planned Production - Underground and Dispersal Program

| | Tons per Month | Total German Production Jan 1944 | Percent |
|-----------------------------|----------------------|--|---------|
| Aviation Gasoline | 130,000 | 159,000 | 82 |
| Motor Gasoline | 30,000 | 118,000 | 25 |
| Diesel Oil | 103,000 | 117,000 | 88 |
| Lubricating Oil - all types | 38,000 | 76,000 | 50 |
| Lubricating Oil - Aviation | 6,000 | 9,000 | 67 |

The 45 projected dispersal plants for refining crude oil had more than enough capacity to handle all the crude oil production in Germany, but they could not replace the motor gasoline produced by hydrogenation and Fischer-Tropsch processes. A German chart of the underground and dispersal program is shown on page 10.

This report is divided into two parts. PART I consists of a discussion of the program and plants in general, including overall cost, labor and production figures. PART II consists of a series of data sheets on individual plants. This information covers locations, parent companies, completion dates, cost and labor estimates, production capacities, simplified flow diagrams and detailed discussions of the individual projects.

The underground and dispersal program may be divided logically by products manufactured, and this report will group them as follows:

- Aviation Fuels
- Motor Gasoline
- Lubricating Oil
- Diesel Fuels

Mineral Oil Security Plan - Based on Underground & Dispersal Program

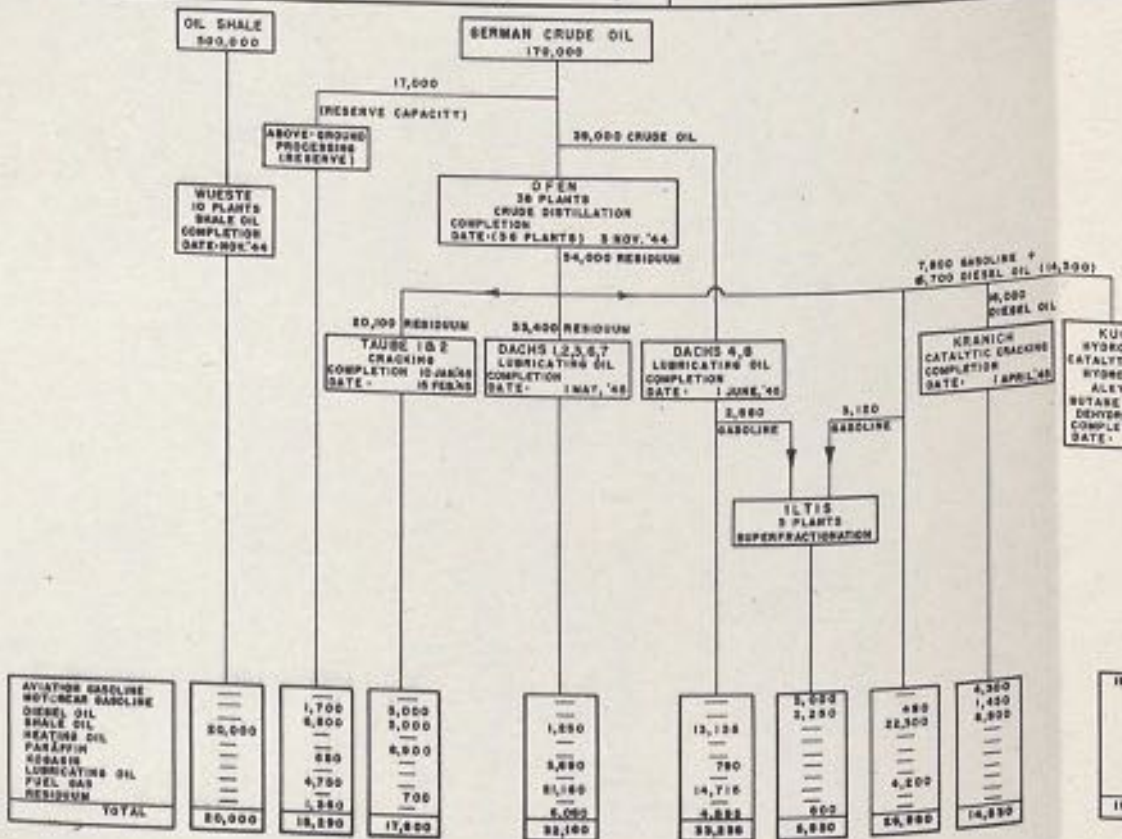

TOTAL PRODUCTION EXPECTED

BROWN COAL TAR PRODUCED IN 19 CARBONIZATION PLANTS
138,000

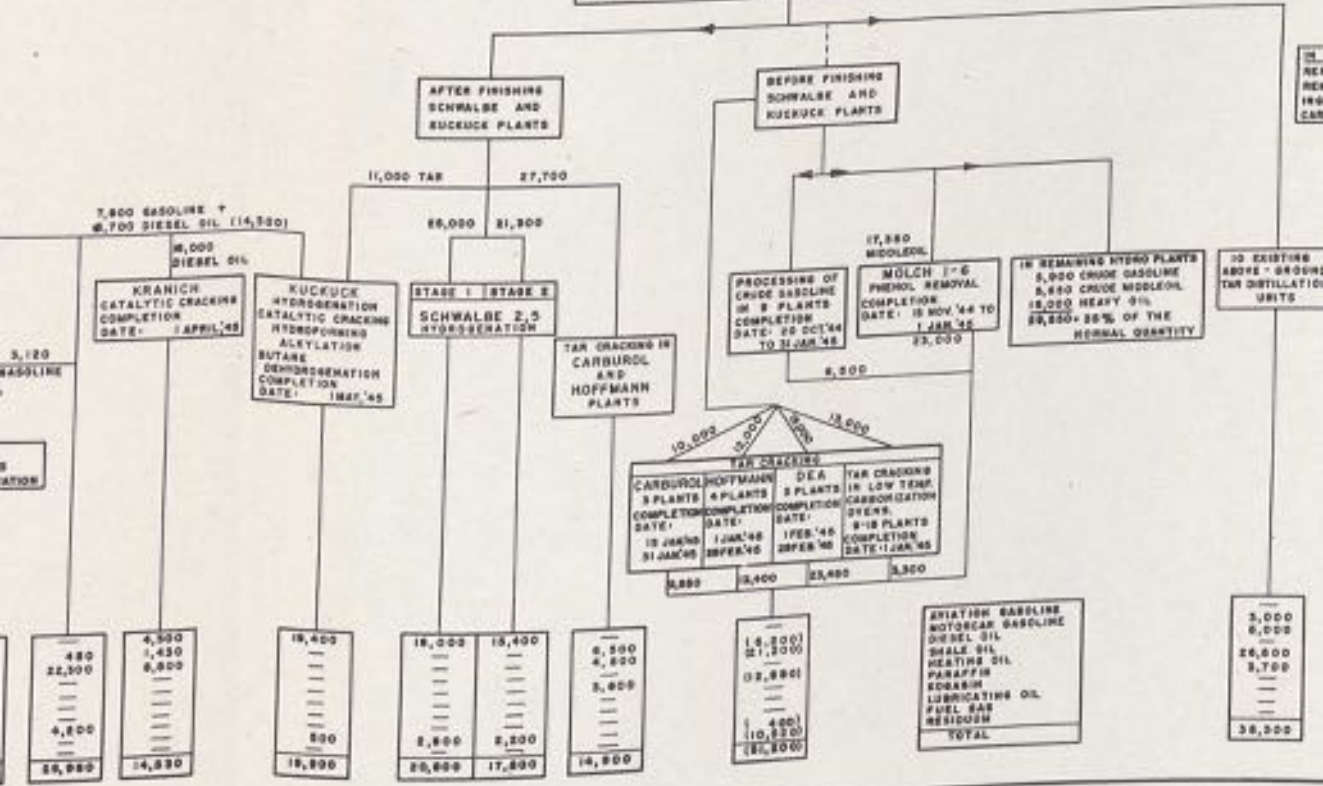

AVIATION FUELS

In January, 1944, aviation gasoline production in Germany was approximately 159,000 tons per month and came almost exclusively from hydrogenation. The attacks in the summer of 1944 reduced this production to one-third of normal and while it recovered to about 50% for a short time, it was reduced by further attacks to about 2% by February, 1945.

As the result of the destruction of aviation gasoline potential, it was decided to move a large proportion of the hydrogenation plants underground in spite of the admitted hazards involved. Since the hydrogenation plants were very large and involved a great deal of equipment, their dispersal required a relatively long period, and in order to avoid losing what capacity was available it was necessary to move the plants in stages. Because of the large areas required, a great deal of excavation was necessary before much could be done in the way of moving equipment and by the time the tunnels were ready, considerable salvaged material was available.

Originally, it was planned that these plants would start production in the summer of 1945. Because of shortage of explosives and transportation, and requirements for a large amount of labor for repairing current damage, the program kept falling behind schedule and it is certain that none of these plants would have started before late Fall. Initially, the program involved eight SCHWALBE or hydrogenation plants, three KUCKUCK aviation gasoline plants, three KYBOL (di-ethylbenzene) plants, three ILTIS or superfractionation plants and a KRANICH or catalytic cracking plant.

SCHWALBE: These were to be high-pressure catalytic hydrogenation plants almost entirely underground (except SCHWALBE 8). These units were to be vapor phase only and were to feed tar and gas oil from crude, as well as tar from coal carbonization and hydrogenation plants in the Ruhr, Central Germany and Upper Silesia. The plants were to be built in two steps, each about half capacity with the second step completed about two months later.

The coal hydrogenation plants were to be left above ground because of the large area required to accommodate them.

The plans for the underground hydrogenation plants were not very far along and apparently the problem of hydrogen production had not been settled. The existing plants manufactured hydrogen by the reaction of steam with coke at high temperatures. This requires large

equipment and feeding of coke in bulk, making it difficult to eliminate leakage of gas, which in an underground plant is, of course, very hazardous. Production of hydrogen by electrolysis of water was suggested, but this would have used a tremendous amount of power and probably would have required construction of new power plants. If these were to have been placed underground, the necessary excavation probably would have been even greater than that for conventional hydrogen manufacturing plants.

In all, eight underground hydrogenation plants were discussed, three of which were to feed tar from carbonization of coal, three were to feed tar from Brown Coal and the other two were to feed gas oil and residuum from crude (see page 19). To a considerable extent, these plants were to be interchangeable as to stocks. The total capacity of these eight plants was 134,000 tons per month of feed stock and they were to produce 92,000 tons per month of aviation gasoline and jet plane fuel.

As a result of shortages of labor, explosives and materials and the loss or threatened loss of plant sites to the Allies, this program was reduced to six plants and finally to two. The status at the end of the war was as follows:

Hydrogenation Plants

- SCHWALBE 1 - Excavation 50% complete.
- 2 - Project switched to nitrogen and methanol production. Excavation just started.
- 3 - Site cleared, ready for excavation. This project was dropped 31 March, 1945.
- 4 - Ready to start excavation. This project was dropped in March, 1945.
- 5 - Excavation about 30% complete.
- 6 - Planning had just been started.
- 7 - Planning only.
- 8 - Planning only.

At the end of the war, only SCHWALBE 1 at Oberroedinghausen and SCHWALBE 5 at Berga were still under construction, with a total anticipated production of 25,000 tons per month.

KUCKUCK: Only one of these plants passed the discussion stage. This was a rather complicated underground installation designed to operate as a self-contained unit feeding only tar from sump phase hydrogenation of coal, gas oil from crude distillation and crude gasoline, and converting it all to gasoline and a small amount of fuel oil. It consisted of the following units:

Two vapor phase hydrogenation plants operating in series to convert coal tar to aviation gasoline.

One catalytic cracking unit to convert straight-run gas oil to aviation gasoline.

One hydroforming or DHD* unit to increase the octane number and aromatic content of straight-run and hydrogenated gasoline.

One alkylation and butane dehydrogenation plant for the production of alkylate (iso-octane).

The capacity of this plant was to be as follows:

| | |
|-----------------------------------|-----------------------------|
| Hydroformed gasoline (DHD) | 8300 tons per month. |
| Aviation gasoline, B ₄ | 9400 tons per month. |
| Alkylate (iso-octane) | <u>1700</u> tons per month. |
| Total aviation gasoline | 19400 tons per month. |

The KUCKUCK was located in a gypsum cliff near Niedersachswerfen. A V-1 and V-2 manufacturing plant, a Junkers aircraft plant and a liquid oxygen plant were also installed in this formation. See page 83.

A considerable number of tunnels were excavated under an arrangement between the WIFO (a government agency concerned with storage of oil, etc.) and I. G. Farben, made in 1935, whereby I. G. Farben was to change their existing open-cut mining of gypsum, to tunneling in order to provide underground storage for oil. These tunnels were used for the V-1, V-2 and Junkers plants.

The tunnel program was later expanded to receive the plants enumerated above, and at the end of the war tunnels for the KUCKUCK were about 60% complete. Only a small amount of equipment had arrived at the plant site by the end of the war.

KYBOL: These units produced di-ethyl-benzene for use as a blending agent to improve the octane number and rich mixture rating of aviation gasoline. It is similar chemically to cumene which is used in the U. S. for the same purpose.

*Druck-H₂-Dehydrierung (literally, pressure-hydrogen-dehydrogenation).

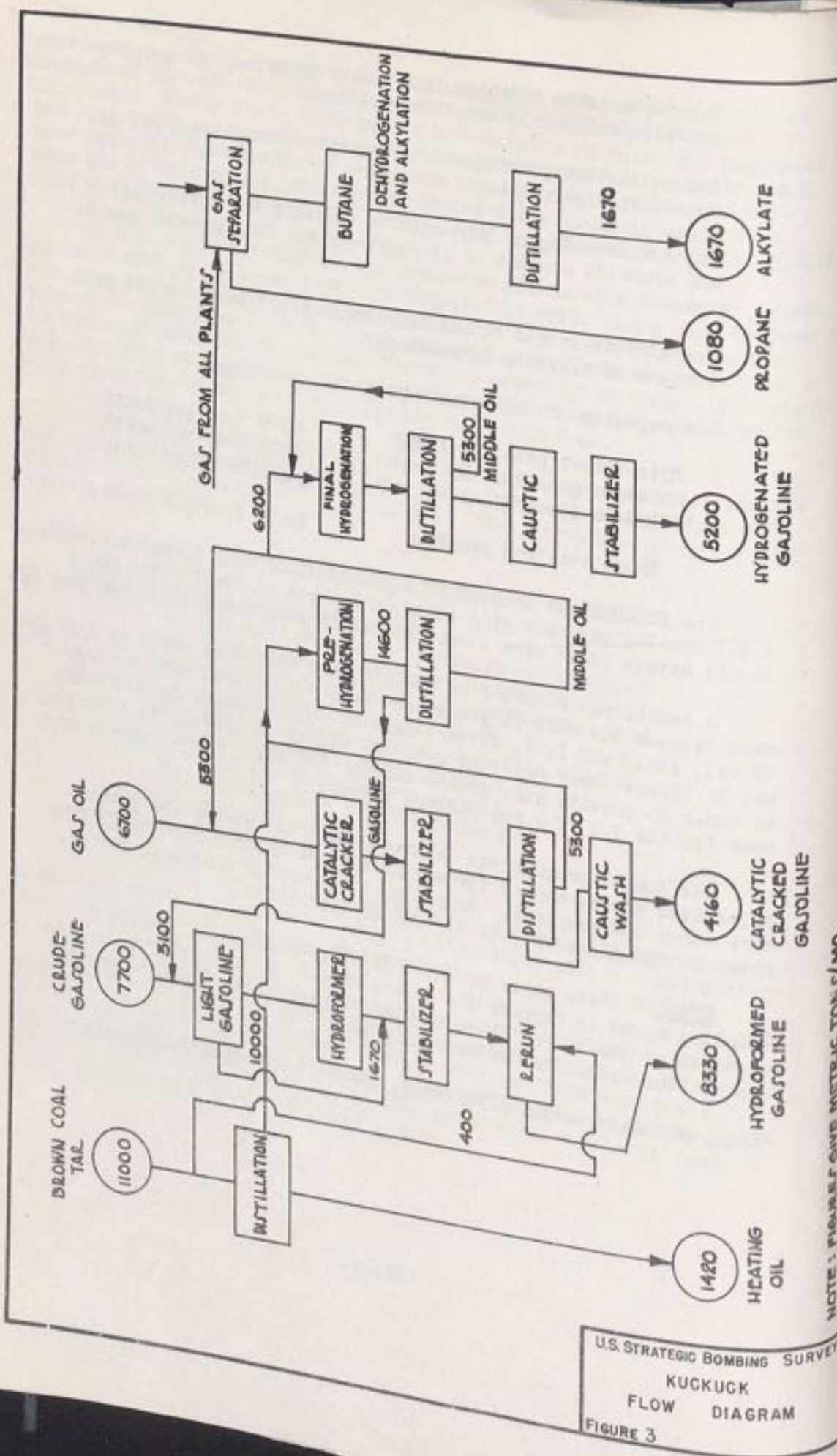

NOTE: FIGURES ARE METRIC TONS (1 MO.)

U.S. STRATEGIC BOMBING SURVEY
 KUCKUCK
 FLOW DIAGRAM
 FIGURE 3

The only KYBOL unit in operation was erected in a building of an existing chemical plant at Gendorf. This plant started operation in January, 1945, and as far as could be determined was the only dispersal plant to operate with the exception of the small crude units.

This plant had a capacity of 1400 tons per month of di-ethylbenzene.

A second di-ethylbenzene plant was originally planned as part of STEINBOCK 2 at Unterloquitz, but was later abandoned (January, 1945).

A third, to be operated in connection with the TAUBE or cracking plant at Deggendorf, was to produce a mixture of ethyl and propyl benzenes for the same purpose. This was known as FASAN 2.

ILTIS: Three of these plants were considered, but two of them were dropped. They were to be superfractionating units for separating high-octane components from motor gasoline for use as aviation blend stocks. The one remaining plant under construction when the war ended would have produced 1000 tons per month of aviation gasoline. It was built above ground and had fractionating columns 130 feet high.

KRANICH: The KRANICH was a catalytic cracking plant with a capacity of 4300 tons per month of aviation gasoline. It was in the planning stage only.

KLEIN SCHOLVEN: When the Scholven hydrogenation plant was destroyed by bombing it was decided to build three small hydrogenation plants to be hidden in the neighborhood. Two of these were to be gas phase and the third a combination gas and sump phase unit.

- - -

The total aviation fuel capacity of the underground plants was to have been approximately as follows:

| | | <u>Tons per Mo.</u> |
|----------------|---------------------------|---------------------|
| SCHWALBE 1-8 | Hydrogenation | 91,900 |
| KUCKUCK 1 | | 19,400 |
| ILTIS 1-3 | Superfractionation | 3,000 |
| KYBOL 1-2 | Di-ethylbenzene | 2,800 |
| FASAN 1-2 | Ethyl and propyl benzenes | 1,500 |
| KRANICH 1 | Catalytic Cracking | 4,300 |
| KLEIN SCHOLVEN | Hydrogenation | <u>7,400</u> |
| | Total - | 130,300 |



Figure 4 - Little Scholven Hydrogen Plant - After the Scholven plant was bombed, equipment was removed and scattered through a woods near Huels. These ovens are normally vertical but were installed almost horizontally to conceal them despite doubt as to their operability. The one at the left is in operating position.



Figure 5 - The high pressure separator and control manifold of one of three dispersed plants built with equipment from Scholven is shown here. The well-camouflaged bunker on the left was the control room; manifold valve handles were extended into this bunker.



Figure 6 - Little Scholven Hydrogenation Plant - This distillation unit was used with the hydrogenation unit shown on the preceding page. These units were a quarter of a mile apart. The bunker on the left was the control house for this part of the plant.



104 Figure 7 - This is a close-up of the distillation furnace and fractionating columns of the plant shown above. This photograph shows the extent to which the equipment was camouflaged: the height of the furnace can be judged by noting the ladder at the right.

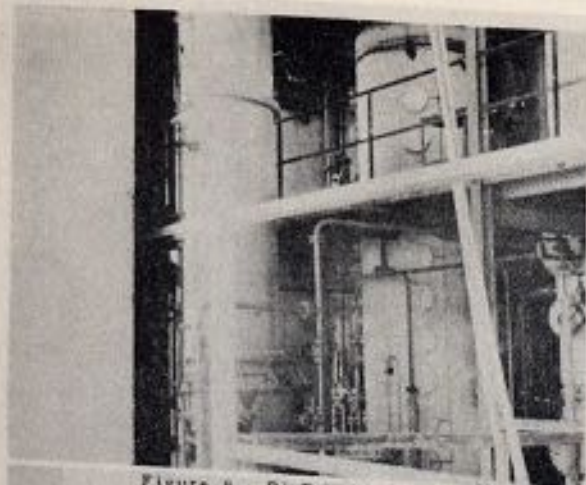

Figure 8 - Di-Ethyl-Benzene - This Kybol unit was erected inside of an existing building of the I.G. Farben chemical plant. This photograph shows the distillation equipment.

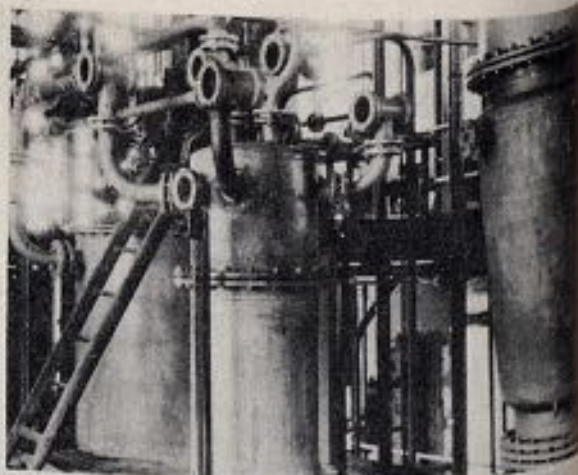

Figure 9 - View of the catalyst chambers and separators of the Kybol.

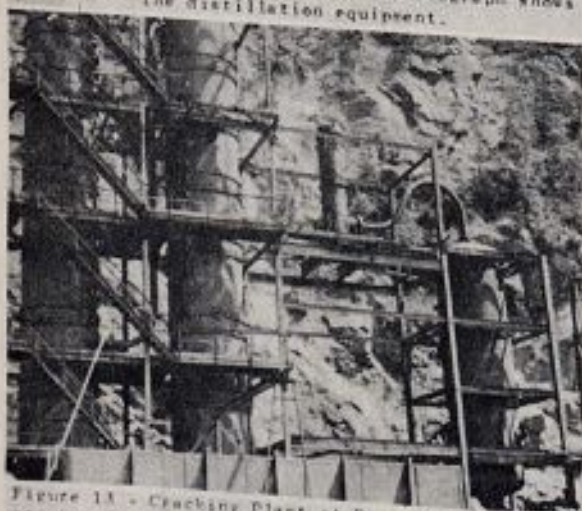

Figure 13 - Cracking Plant at Deggendorf - These are two fractionators and a flash drum of a cracking plant protected by a cliff along the Danube. This was one of two relatively modern units built to produce gasoline, diesel and fuel oils from tar.

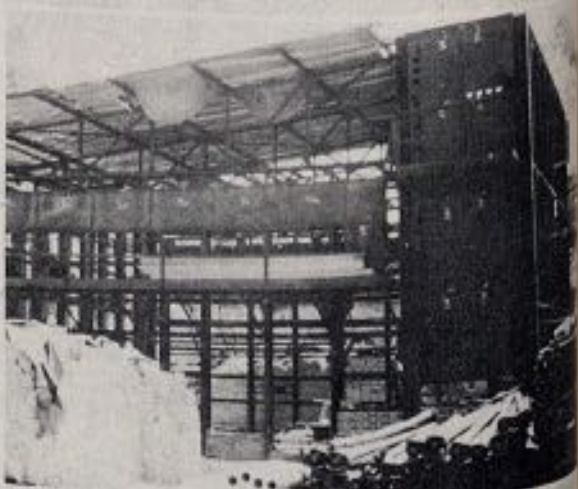

Figure 14 - This is a close-up of the cracking furnace of the plant shown above. It was under construction when the war ended. This was the second time that this equipment had been moved. This one project required six months labor by 4,000 men.

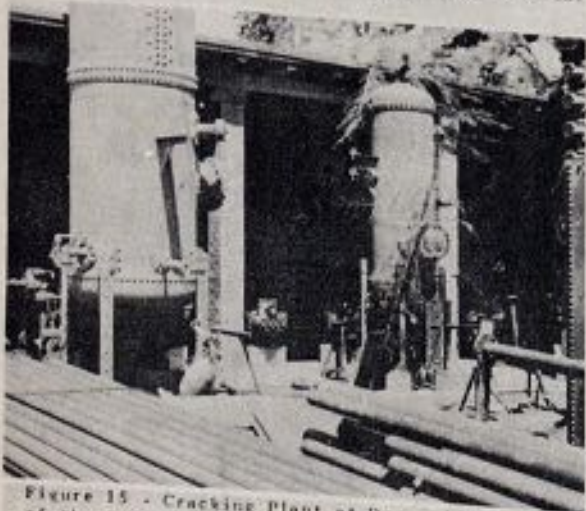

Figure 15 - Cracking Plant at Deggendorf - View of the pump house and receiving drums.



Figure 16 - Cracking Plant at Deggendorf - The tank field was not protected. Dunny tanks were made of plywood and apparently used for quarters.

SECURITY PLAN

HYDROGENATION PL UNDERGROUND & DISPERSA

COAL TAR
THRUPUT=46500

BROWN COAL TAR
THRUPUT=57300

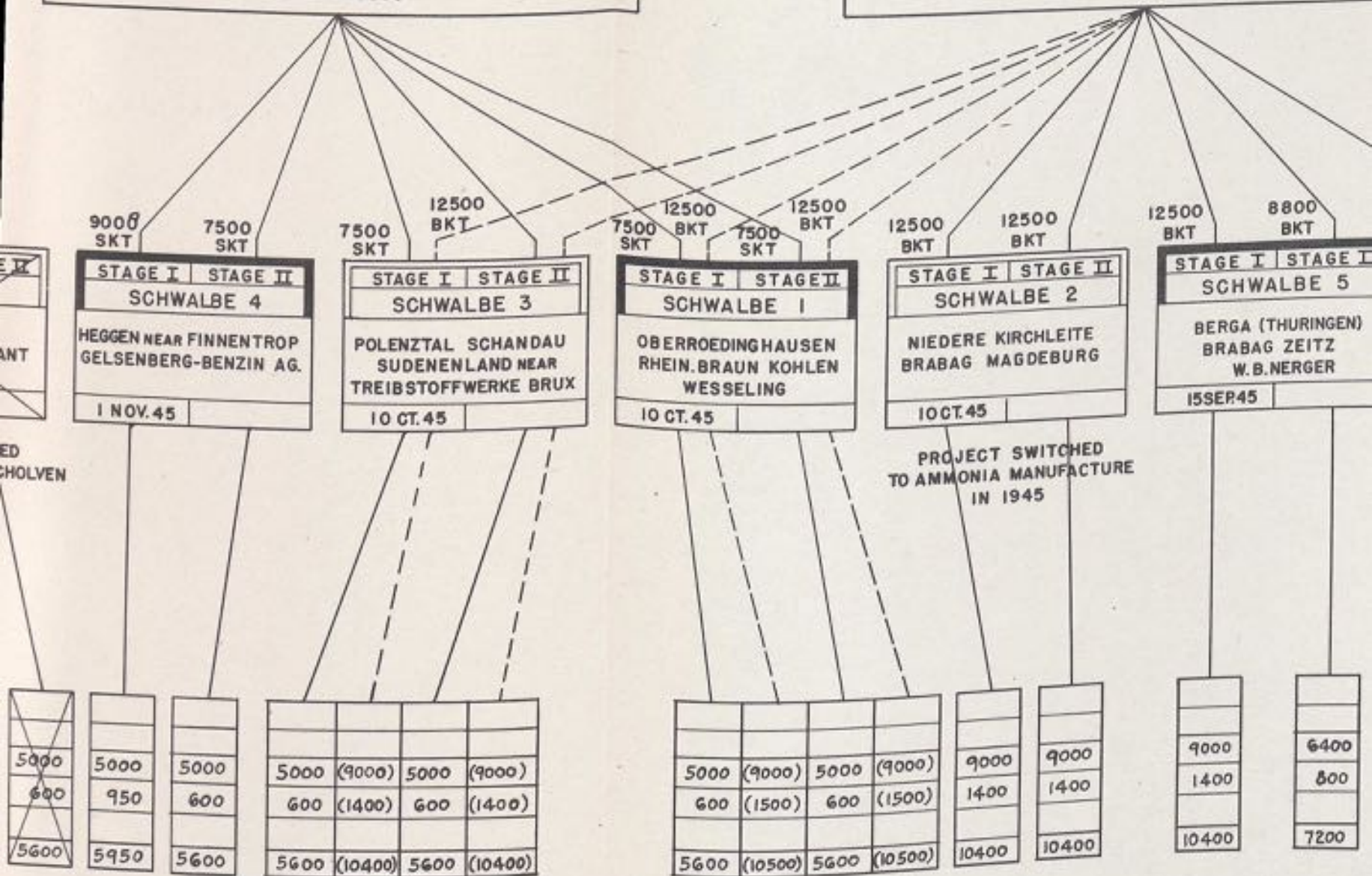

ANTS
L

STATUS AS OF 22 NOV. 44
METRIC TONS PER MONTH

| CRUDE OIL DISTILLATION | | |
|------------------------|------------------|-------------------|
| GASOLINE 7800 | GAS OIL 22700 | RESIDUUM 20000 |

┌ UNDER CONSTRUCTION
└ PROJECTED

7800
CRUDE
GASOLINE

6700
GAS OIL

16000
GAS OIL

11000
BKT

KUCKUCK

NIEDERSACHSWERFEN
I.G. -LEUNA

SCHWALBE 8

TETSCHEN

STAGE I | STAGE II
SCHWALBE 7

WOLLIN
WELHEIM

LEGEND:

CODE NAME - SCHWALBE 5
LOCATION - BERGA (THURINGEN)
PARENT COMPANY - BRABAG ZEITZ
COMPLETION DATE:

| |
|-------|
| 8300 |
| 1700 |
| 9400 |
| 500 |
| |
| 19900 |

| | |
|-------------------|-------|
| MOTOR GASOLINE | 1400 |
| | |
| | 4500 |
| | |
| | 8800 |
| | 14700 |

| |
|------|
| |
| |
| 7000 |
| 900 |
| |
| 7900 |

| |
|------|
| |
| |
| 7000 |
| 900 |
| |
| 7900 |

| |
|--------|
| 1400 |
| 8300 |
| 1700 |
| 101300 |
| 12450 |
| 8800 |
| 133950 |
| |

FIGURE 10

Figure 11 page 22 shows actual production for 1944 and the development of planned capacity for the production of aviation gasoline by the underground and dispersal plants on the assumption that the original program was carried out. It is evident that the program would have had to start at least a year earlier in order to be effective.

These plants were to be built at an estimated cost of about 1,100,000,000 RM. of which approximately 200,000,000 RM. was expended up to the end of the war. This would correspond to a total manpower requirement diverted from German industry of nearly 50,000,000 man days or over 160,000 man years. This estimate of manpower included the labor required for fabrication of equipment from raw materials and represents roughly the total drain on German manpower required for this project. See page 67 for basis.

AVIATION GASOLINE

(Greater Germany)

COMPLETION DATES - UNDERGROUND AND DISPERSED PLANTS

| <u>Completion Date</u> | <u>Plant</u> |
|------------------------|--|
| 1 Feb 1945 | Kybol |
| 1 June 1945 | (Iltis 1 (Klein Scholven 1, 2 (Steinbock 2 |
| 1 July 1945 | Klein scholven 3 |
| 1 Sept 1945 | Fasan 2 |
| 1 Oct 1945 | Schwalbe 5 |
| 1 Nov 1945 | Kuckuck |
| 15 Nov 1945 | Schwalbe 1 |
| 1 Apr 1946 | Schwalbe 2 |
| 1 May 1946 | Schwalbe 3, 4 |
| 1 June 1946 | (Schwalbe 6, 7, 8 (Iltis 2, 3 |
| 1 July 1946 | Kranich |

MONTHLY AVERAGE

PLANNED CAPACITY OF UNDERGROUND AND DISPERSAL PLANTS COMPARED TO TOTAL GERMAN PRODUCTION

AVIATION GASOLINE

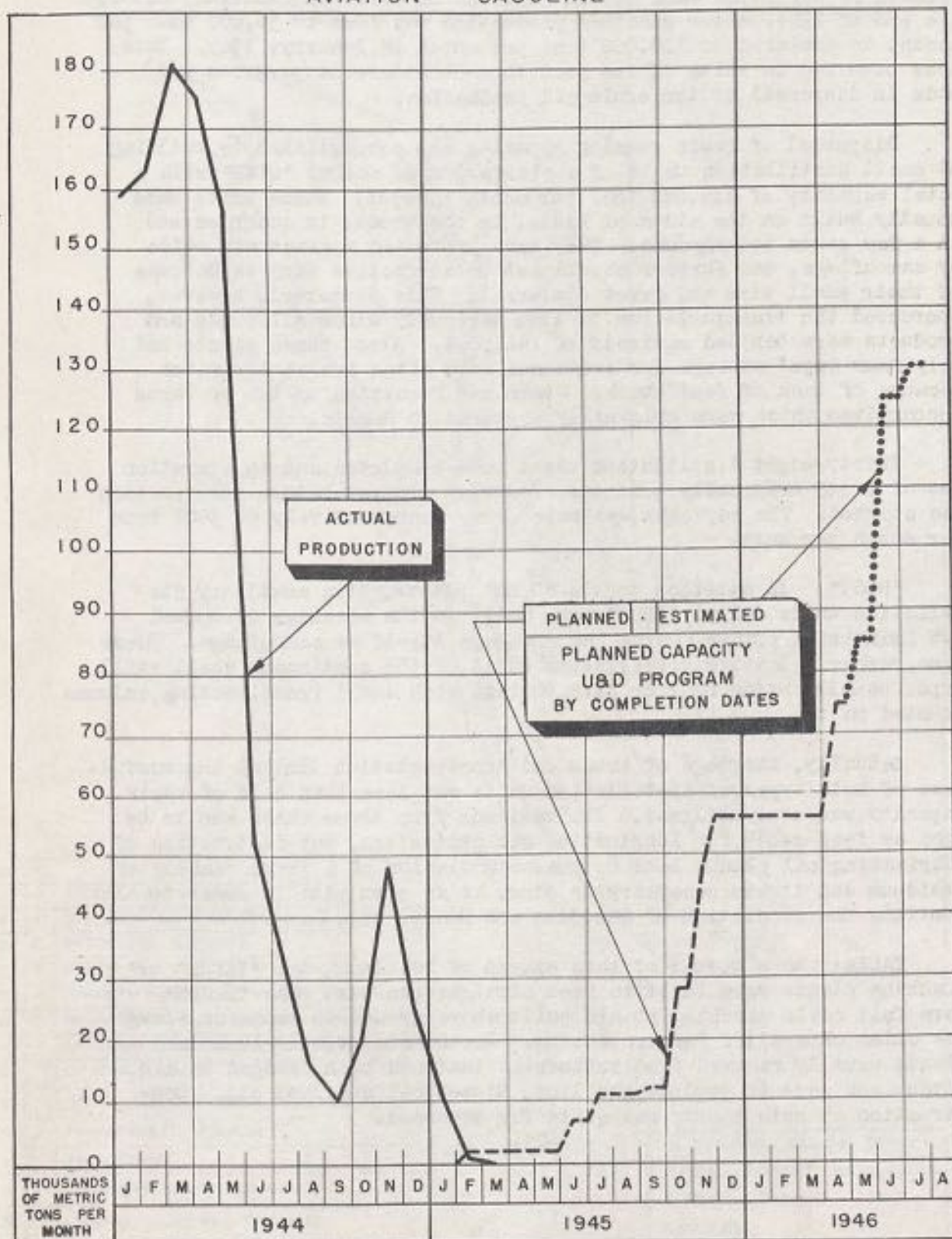

FIGURE 11

MOTOR GASOLINE

Motor gasoline was produced at the crude oil refineries and hydrogenation plants and included some Benzol from carbonization coal. Since motor gasoline was produced in a large number of plants, the effects of air raids were not as acute as on aviation gasoline, but by the end of 1944, motor gasoline production was down to 50,000 tons per month, as compared to 118,000 tons per month in January, 1944. This loss occurred in spite of the fact that considerable progress was made in dispersal of the crude oil production.

Dispersal of crude running capacity was accomplished by building 38 small distillation units of a standard type called "OFEN" with a total capacity of 114,000 tons per month thruput. These units were usually built on the sides of hills, in the woods, in quarries and in a few cases underground. They were protected against air raids by camouflage, and further should not be attractive targets because of their small size and great dispersal. This dispersal, however, increased the transportation problem seriously since all crude and products were handled entirely by railroad. Also, these plants had only four days' storage for crude and were often run at low rates because of lack of feed stock. Steam was furnished by two or three locomotives which were originally captured in Russia.

Thirty-eight distillation units were completed and in operation out of forty originally planned. Two were dropped before construction was started. The capacity was rated very conservatively at 3000 tons per month per unit.

"ROST": In addition to the "OFEN" plants, five auxiliary distillation units called "ROST" were built in the wreckage of bombed out industrial plants, using the wreckage itself as camouflage. These were rather primitive distillation units of the continuous shell still type, usually using four or five boilers with small fractionating columns mounted on top.

Actually, shortage of crude and transportation limited the usefulness of both types of distillation units and less than half of their capacity was ever utilized. The residuum from these units was to be used as feed stock for lubricating oil production, but destruction of lubricating oil plants lead to the accumulation of a large backlog of residuum and it was necessary to store it in open pits in order to continue the production of gasoline and Diesel oil.

TAUBE: As a result of this excess of residuum, two "TAUBE" or cracking plants were built to feed straight-run tar. The "TAUBE" were full scale cracking plants built above ground in woods or along the sides of a cliff for protection. These were relatively modern plants usually removed from refineries that had been damaged by air attack and were to produce gasoline, Diesel oil and fuel oil. Construction on both plants was quite far advanced.

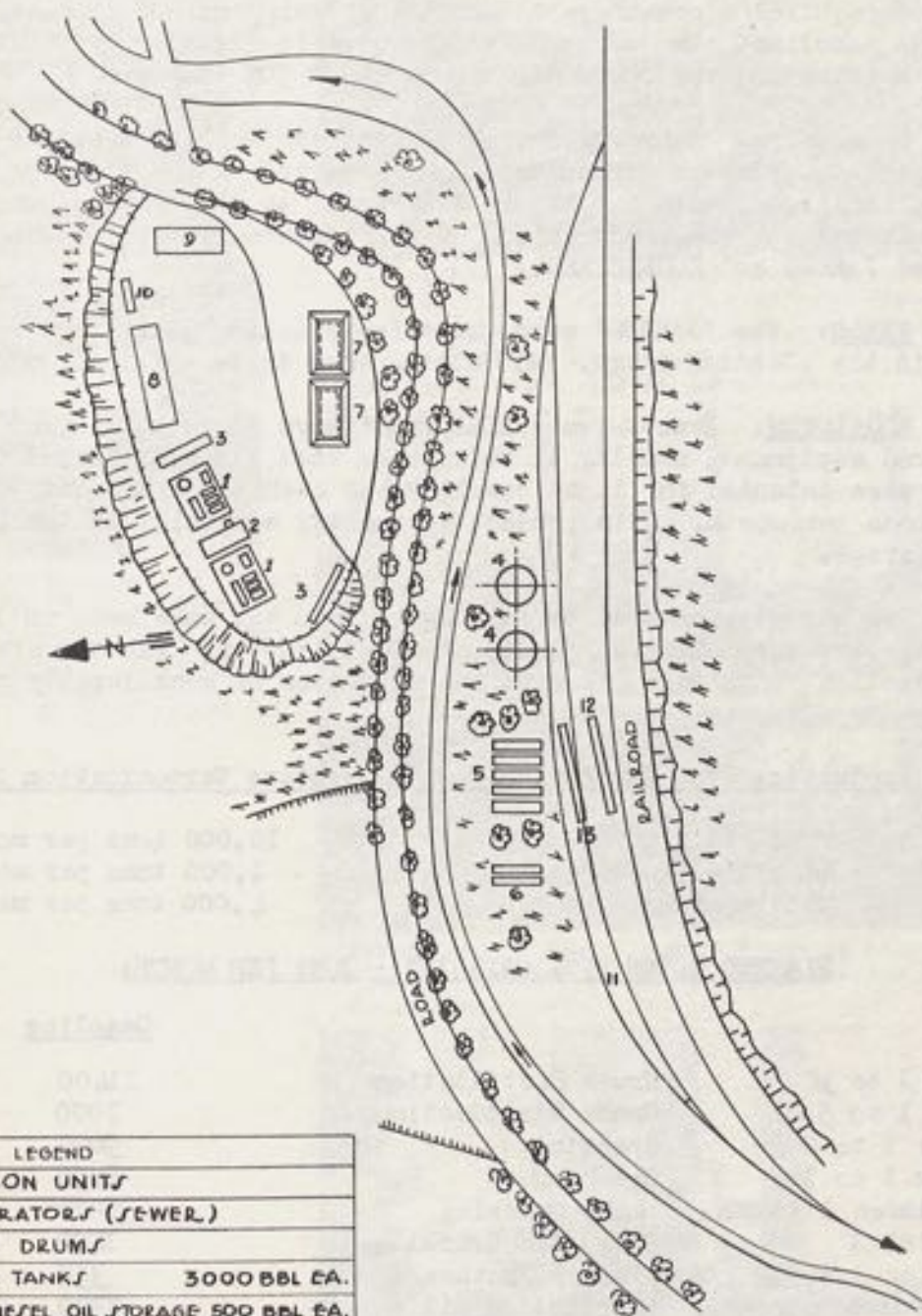

| BLDG. NO. | LEGEND |
|-----------|---|
| 1 | 2 DISTILLATION UNITS |
| 2 | 1 OIL SEPARATORS (SEWER) |
| 3 | 2 DESALTING DRUMS |
| 4 | 2 CRUDE OIL TANKS 3000 BBL EA. |
| 5 | 5 FINISHED DIESEL OIL STORAGE 500 BBL EA. |
| 6 | 2 FINISHED GASOLINE STORAGE 500 BBL EA. |
| 7 | 2 RESIDUUM SUMP (CONCRETE) 3000 BBL EA. |
| 8 | RECEIVING HOUSE |
| 9 | OFFICE, SHOP, STOREROOM AND LABORATORY |
| 10 | TRANSFORMER STATION |
| 11 | SPUR TRACKS |
| 12 | UNLOADING RACKS FOR CRUDE |
| 15 | LOADING RACKS FOR PRODUCTS |

U.S. STRATEGIC BOMBING SURVEY
 TYPICAL "OFEN" INSTALLATION
 SMALL TOPPING UNIT
 FIGURE 12

KARPFEN: The "KARPFEN" were small Fischer-Tropsch plants built above ground in the vicinity of existing city gas works. The water gas used for city gas supply was fed through these plants to produce a small amount of motor gasoline and Diesel oil synthetically. These plants required a considerable amount of equipment and produced very little gasoline. Two of these plants were in the advanced stages of construction and the other eight were about 50% complete.

Destruction of hydrogenation plants resulted in an excess of tar from low-temperature carbonization of coal and it was necessary to build cracking plants for its utilization. As a result, a program was started for the construction of thirty three small cracking units called JAKOBS and KUGELOFENS.

JAKOB: The "JAKOBS" were primitive cracking plants and were only in the planning stage. All eleven were to be built above ground.

KUGELOFEN: Twenty-two "KUGELOFENS" were to be built from reclaimed equipment, usually in refineries that had been bombed out. They were intended for light cracking and each had a capacity of 700 tons per month. This project apparently was still in the planning stage.

Tar was also cracked by feeding it into the coke beds of low-temperature carbonization plants at about 1300° F. The tar cracked to gasoline and middle oil with the formation of considerable cracked gas.

Production From Tar Fed to Low Temperature Carbonization Plants

| | |
|-------------------|------------------------|
| Feed (10 plants) | 10,000 tons per month. |
| Gasoline produced | 1,000 tons per month. |
| Middle oil | 4,000 tons per month. |

PLANNED MOTOR FUEL CAPACITY - TONS PER MONTH:

| | | <u>Gasoline</u> | <u>Diesel Oil</u> |
|-------------------|--------------------|-----------------|-------------------|
| Ofen 1 to 38 | Crude Distillation | 11400 | 45600 |
| Rost 1 to 5 | Crude Distillation | 7000 | 28000 |
| Thube 1 to 2 | Cracking | 5000 | 3000 |
| Jakob 1 to 11 | Cracking | 8250 | 6900 |
| Kugelofen 1 to 22 | Light Cracking | 3000* | 3000 |
| Kranich 1 | Catalytic Cracking | 1400 | 8800 |
| Karpfen 1 to 10 | Fischer Synthesis | 350 | 400 |
| Dachs 1 to 6 | Lubricating Oil | 3300 | 16400 |
| Schwalbe 8 | Hydrogenation | <u>1400</u> | <u>8800</u> |
| | TOTAL | 41100 | 120900 |

*Estimated

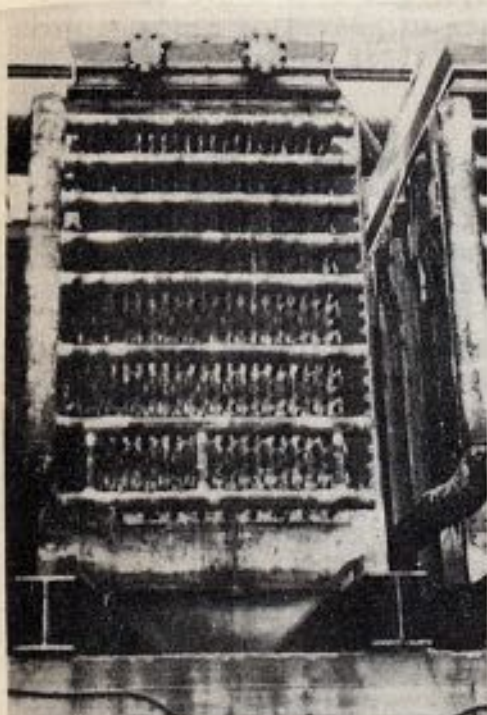

Figure 19 - Fischer-Tropsch Plant at Leipzig - Close-up of Fischer oven. The catalyst bed is filled with cooling coils to control catalyst temperature.

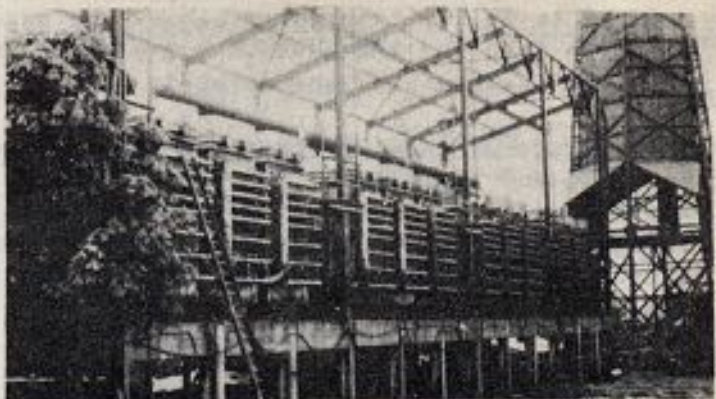

Figure 17 - Fischer-Tropsch Plant at Leipzig - This was the largest of 10 dispersed plants attached to city gas works throughout Germany. The 12 reactors shown above were removed from the bombed-out plant at Luetzkendorf.

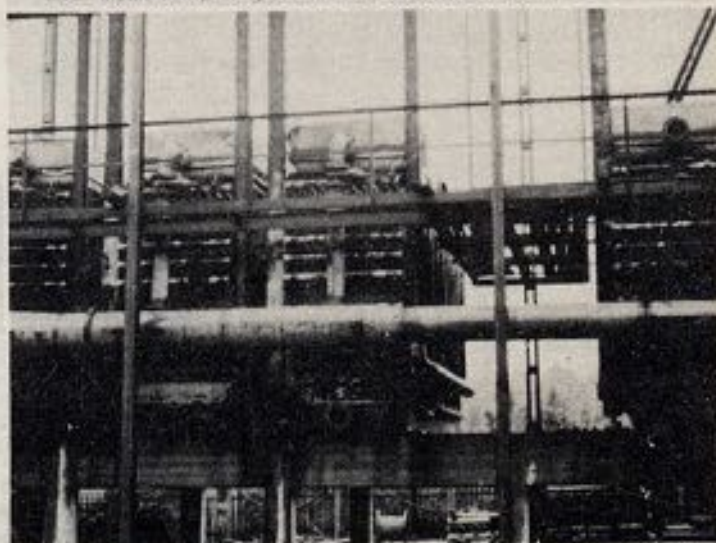

Figure 18 - Fischer-Tropsch Plant at Leipzig - This is a rear view of the ovens showing the steam and gas piping.



Figure 20 - Fischer-Tropsch Plant at Leipzig - This equipment is used for removing sulphur from the gas fed to the ovens.

This figure of 41,100 tons per month of motor gasoline would be reduced to 31,000 tons per month by the necessity of providing crude gasoline feed for the KUCKUCK hydroformer and the ILTIS superfractionation plants when they are started.

Figure 21 page 32 shows the actual production of motor gasoline for 1944 and the planned development of the motor gasoline capacity of the dispersal program. It is evident that the dispersal program even though capable of handling all of the German crude production, would supply only a minor part of the motor gasoline requirements.

Figure 22 page 33 is a reproduction of a German flow chart showing the processing of Brown Coal tar products.

The cost of the program for the production of motor gasoline is estimated to be about 85,000,000 RM. or about 12,000 man years of labor.

SECURITY

PROCESSING OF BROWN COAL
EMERGENCY PROGRAM FOR LOSS OF HYDROGENATION

NORMAL PRODUCTION OF BROWN COAL

| | | | | | | | | | | |
|----------------------|--|--|--|----------------|--------------------------------------|--|---------------------------------------|--|---------------------|---------------------|
| NACHTERSTEDT 7800 | | RIEBECK DEUBEN 7700 KUPFERHAMMER 1500 | | V.VOSS 3200 | AKW GROITZSCHEN 3600 KÖPSEN 300 | | ASW ESPENHAIN 27000 BÖHLEN 24700 | | HIRSCHFELDE 6800 | SALZ DEU 6800 |
| 7000 CRUDE GASOLINE | | | | | NORMAL 85000 IN | | | | | |
| | | | | | 1500 CRUDE HEAVY GASOLINE | | | | | |

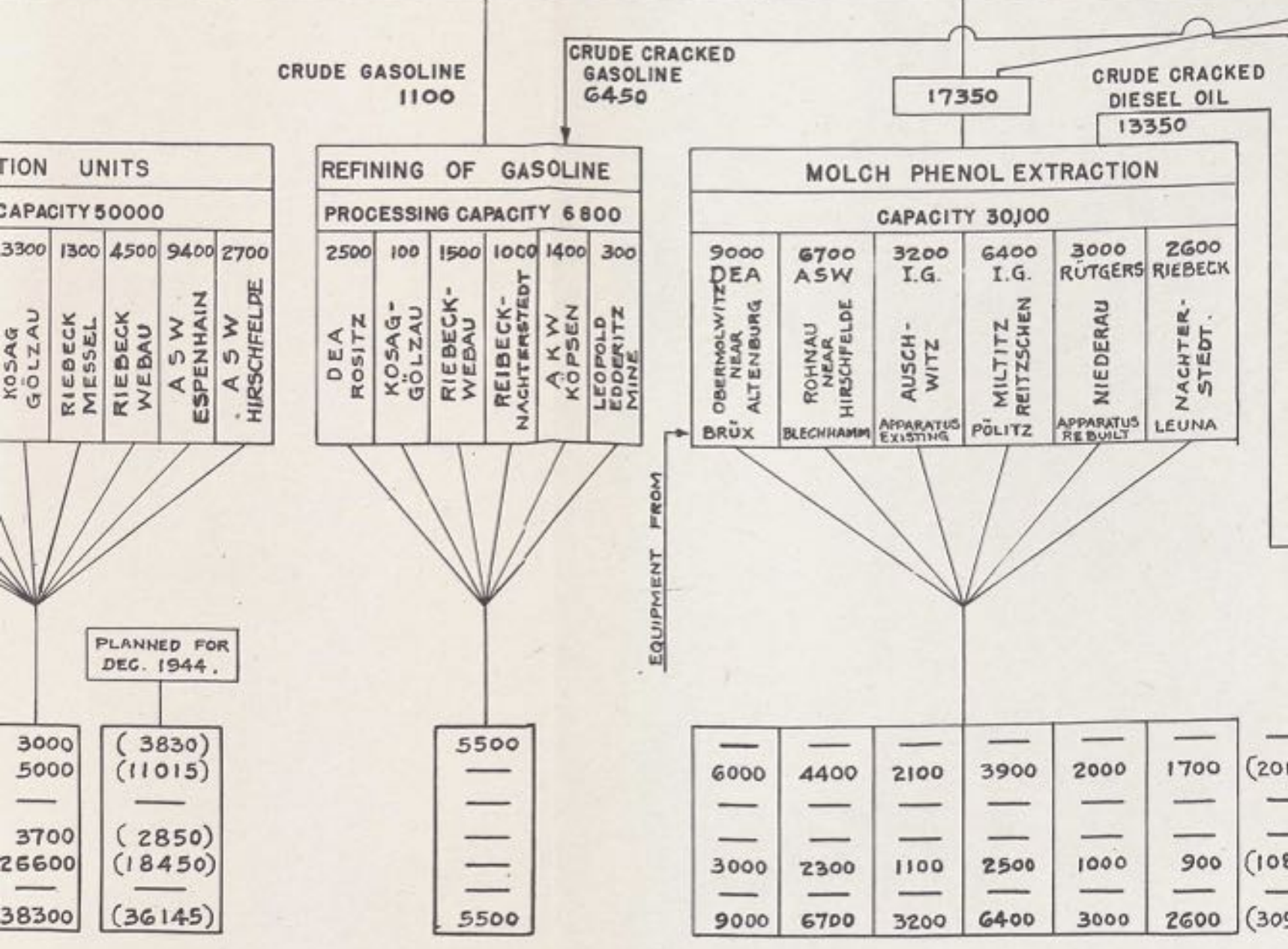

**COAL TAR
PLANT PRODUCTION.**

STATUS AS OF 22 NOV.44
METRIC TONS PER MONTH

COAL TAR

| | | | | | | | |
|------------------------|-----------------------|----------------|-------------------------------|-------------------------|-------------------|----------------------------------|-------------------------------|
| ETZURTH TZEN 300 | DEA REGIS 18600 | ROSIKZ 3400 | HEFRAG WÖLFERSHEIM 3400 | KOSAG GÖLZAU 5400 | KULKOWITZ 2400 | LEOPOLD EDDERITZ MINE 1200 | PROFEN FROM JAN.45 3000 |
|------------------------|-----------------------|----------------|-------------------------------|-------------------------|-------------------|----------------------------------|-------------------------------|

HYDRO PLANTS

21500 CRUDE MIDDLE OIL

55000 HEAVY OILS

40000

JACOB

PRIMITIVE CRACKING PLANTS

| | | | | | | | | | | |
|------------------------|---------------|----------------------|----------------------|---------------|-------------|-------------------|-------------------|--------------------------|-------------------------------|-------------------------------|
| 3000 DONAU- CHEM | 3000 ASW | 3000 ASW | 3000 ASW | 3000 I.G. | 5000 ASW | 5000 RIEBECK | 5000 DEA | 2000 RHEIN PREUSEN | 4000 AKW | 4000 BRABAG |
| STATZENDF | HIRSCHFELDE | BERBERSDORF NORTH | BERBERSDORF SOUTH | BÖGERHOF | BRAUNSDORF | GROSS STÖBNITZ | KAMMERS- FORST | HEDERS- LEBEN | MARIANNENS GLÜCK | "ADA" MINE |
| HOFF- MANN | HOFF- MANN | HOFF- MANN | HOFF- MANN | HOFF- MANN | DEA | DEA | DEA | CARBURDL MÖRS | CARBURDL ESSEN GASOLINE | CARBURDL SCHWARZ- HEIDE |

| | | | | | | | | | | | |
|-----|-----|-----|-----|-----|------|------|------|-----|------|------|------------------|
| 750 | 750 | 750 | 750 | 750 | 400 | 400 | 400 | 500 | 1000 | 720 | CRUDE GASOLINE |
| 600 | 600 | 600 | 600 | 600 | 2950 | 2950 | 2950 | 500 | 1000 | 1120 | CRUDE DIESEL OIL |

| | | | | | | | | | | | | | |
|------|------|------|------|------|------|------|------|-----|------|------|---------|-------|------------------------------|
| — | — | — | — | — | — | — | — | — | — | 720 | (720) | 9220 | MOTOR GASOLINE |
| — | — | — | — | — | — | — | — | — | — | 1120 | (1120) | 26220 | DIESEL OIL |
| — | — | — | — | — | — | — | — | 80 | 160 | 160 | (400) | 400 | LIQUIFIED PETRO- LEUM GAS |
| — | — | — | — | — | — | — | — | — | — | — | — | 3700 | PARAFFIN |
| 300) | 450 | 450 | 450 | 450 | — | — | — | — | — | 280 | (2530) | 39930 | HEATING OIL |
| — | 900 | 900 | 900 | 900 | 1200 | 1200 | 1200 | 720 | 1440 | 1360 | (11620) | 11620 | PITCH |
| 900) | 1350 | 1350 | 1350 | 1350 | 1200 | 1200 | 1200 | 800 | 1600 | 3640 | (16390) | 91090 | TOTAL |

FIGURE 22

MOTOR GASOLINE

(Greater Germany)

COMPLETION DATES - UNDERGROUND AND DISPERSAL PLANTS

| <u>Completion Date</u> | <u>Plant</u> |
|------------------------|--|
| 1 Nov 1944 | Ofen 1 - 38 |
| 1 Feb 1945 | Rost 1 - 5 |
| 1 May 1945 | (Jakob 3, 9 (Karpfen 1, 5, 6 (Taube 1, 2 |
| 1 June 1945 | (Iltis 1 (Jakob 1, 2, 4, 10 (Karpfen 2, 3, 4 |
| 1 July 1945 | (Jakob 5 (Karpfen 7, 8, 9, 10 |
| 1 Nov 1945 | Kuckuck |
| 1 Dec 1945 | Jakob 6, 7, 8, 11 |
| 1 Feb 1946 | Dachs 4, 5 |
| 1 May 1946 | Dachs 8 |
| 1 June 1946 | (Iltis 2, 3 (Kranich (Kugelofen (Schwalbe 8 |

MONTHLY AVERAGE

PLANNED CAPACITY OF UNDERGROUND AND DISPERSAL PLAN COMPARED TO TOTAL GERMAN PRODUCTION MOTOR GASOLINE

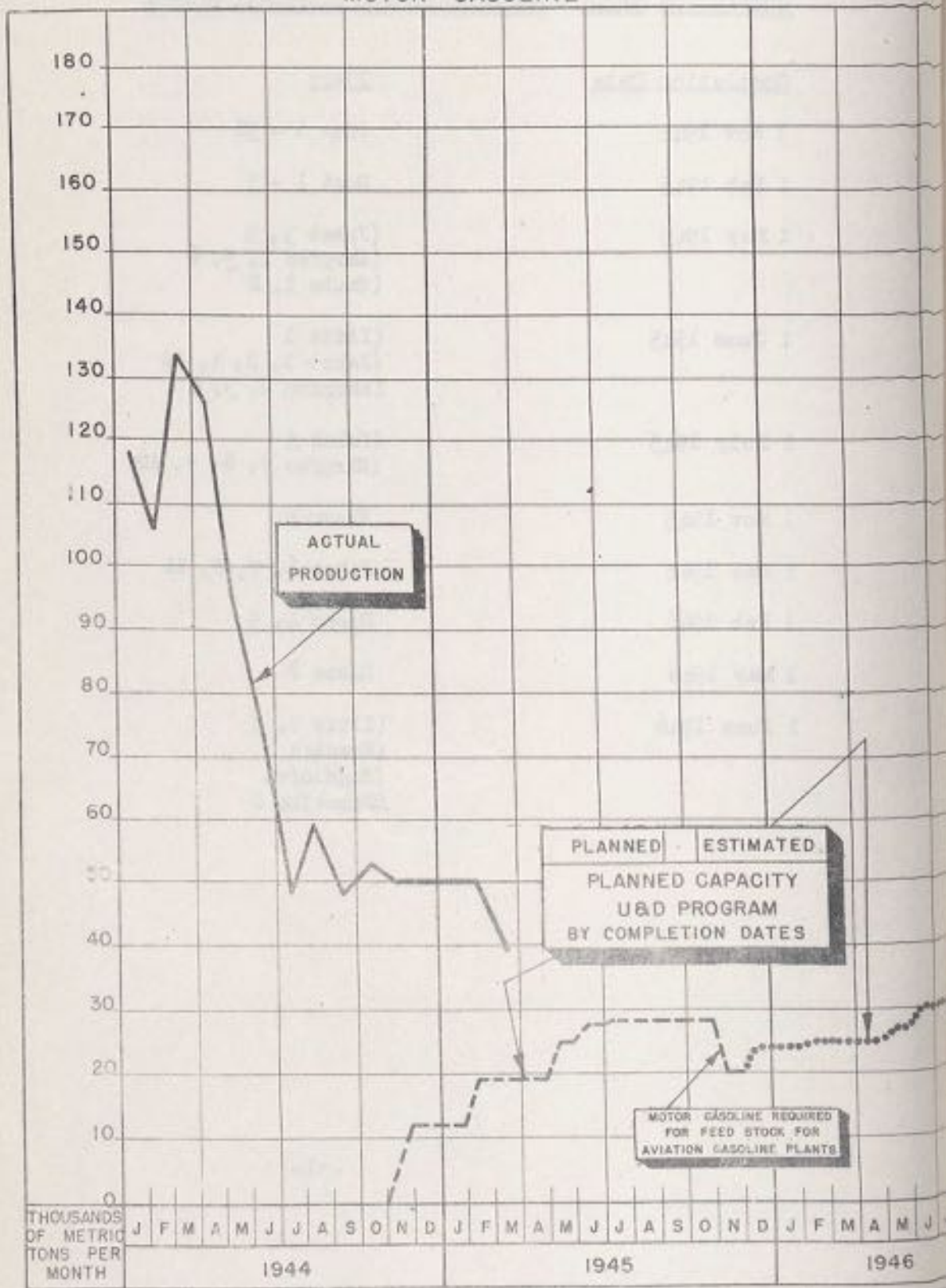

FIGURE

LUBRICATING OIL

In January, 1944, production of lubricating oil was about 76,000 tons per month, of which about 12% was aviation grade oil. The remainder was used for motor oil and industrial oils.

Lubricating oil production was almost entirely confined to crude oil refineries and since the processes are rather complex, considerable storage of intermediate products is required. Usually, when a plant is producing several kinds of lubricating oil, storage of intermediate products will amount to one or two month's output of the plant. As a result, these lubricating oil plants were particularly vulnerable to damage from air attack and there was a serious loss of lube oil production in 1944. It had not reached the critical stage because the loss in gasoline production had reduced the demand for lubricating oil.

Because of the fact that lube oils require several different refining steps in their production, it is not feasible to disperse them as was done with the crude distillation units and, in order to assure lubricating oil production, it was believed essential to locate these plants underground. In all, six plants were to be built underground and two were to be hidden in woods and valleys. These "DACHS" plants were quite complete in all details and included vacuum distillation, furfural extraction, propane de-asphalting, dewaxing, sulfuric acid treating, clay treating and in two cases, synthetic lube oil production. They produced all grades of lubricating oils from light spindle oil through the heavy cylinder oils and waxes and both aviation and motor grades of oil.

The lubricating oil plants were further along than the rest of the underground program and one of them, at Porta, was nearly complete. Figure 23 page 36 is a pictorial layout of this plant showing the equipment in place in the tunnels. Note that in some places there are two and even three floors in the tunnels, each carrying equipment. Figures 24 to 35 are photographs taken in the same plant.

Figure 36 page 44 shows the planned capacity for lubricating oil production of the underground program and actual German production for 1944.

Figure 37 page 45 is a reproduction of a German flow-chart showing the processing of all available German crude oil through the dispersed distillation units and the cracking and underground lubricating oil plants.

The following table indicates the production capacities and status of the work on the eight (8) lubricating oil plants:

Underground Lubricating Oil Plants - Capacity And Status

| | <u>CAPACITY T/MO.</u> | | | <u>STATUS</u> |
|---------|-----------------------|------------------|---------------------|--|
| | <u>Machine Oil</u> | <u>Motor Oil</u> | <u>Aviation Oil</u> | |
| Dachs 1 | 3000 | 1950 | 500 | Nearly complete. |
| 2 | 3000 | 2000 | 1800 | 8 "OFENS" in operation underground. Starting installation of treating equipment. |
| 3 | 840 | 930 | | Finish about 1 August, 1945. |
| 4 | 6635 | 2200 | 700 | Excavation 30% complete. |
| 5 | | 1000 | 2000 | Abandoned. |
| 6 | 800 | 2400 | | Abandoned. |
| 7 | 1300 | 1900 | | Erection of equipment just starting. |
| 8 | <u>4160</u> | <u> </u> | <u>720</u> | Abandoned. |
| TOTAL | 19735 | 12380 | 6020 | |

If the war had continued and transportation had been available, the lubricating oil situation would have been reasonably favorable by the Fall of 1945.

Paraflow, a lube oil additive, used for depressing the "pour point" was to be manufactured in an underground plant at Unterloquitz. This plant (STEINBOCK 2) originally was to manufacture hydrogenation catalyst, paraflow and di-ethyl-benzene (KYBOL plant). Later the "KYBOL" was dropped in order to expedite work on the paraflow plant.

It is estimated that the cost of the Paraflow unit and the eight lubricating oil plants would have been about 169,000,000 RM. The total cost in manpower would have been approximately 25,000 man years.

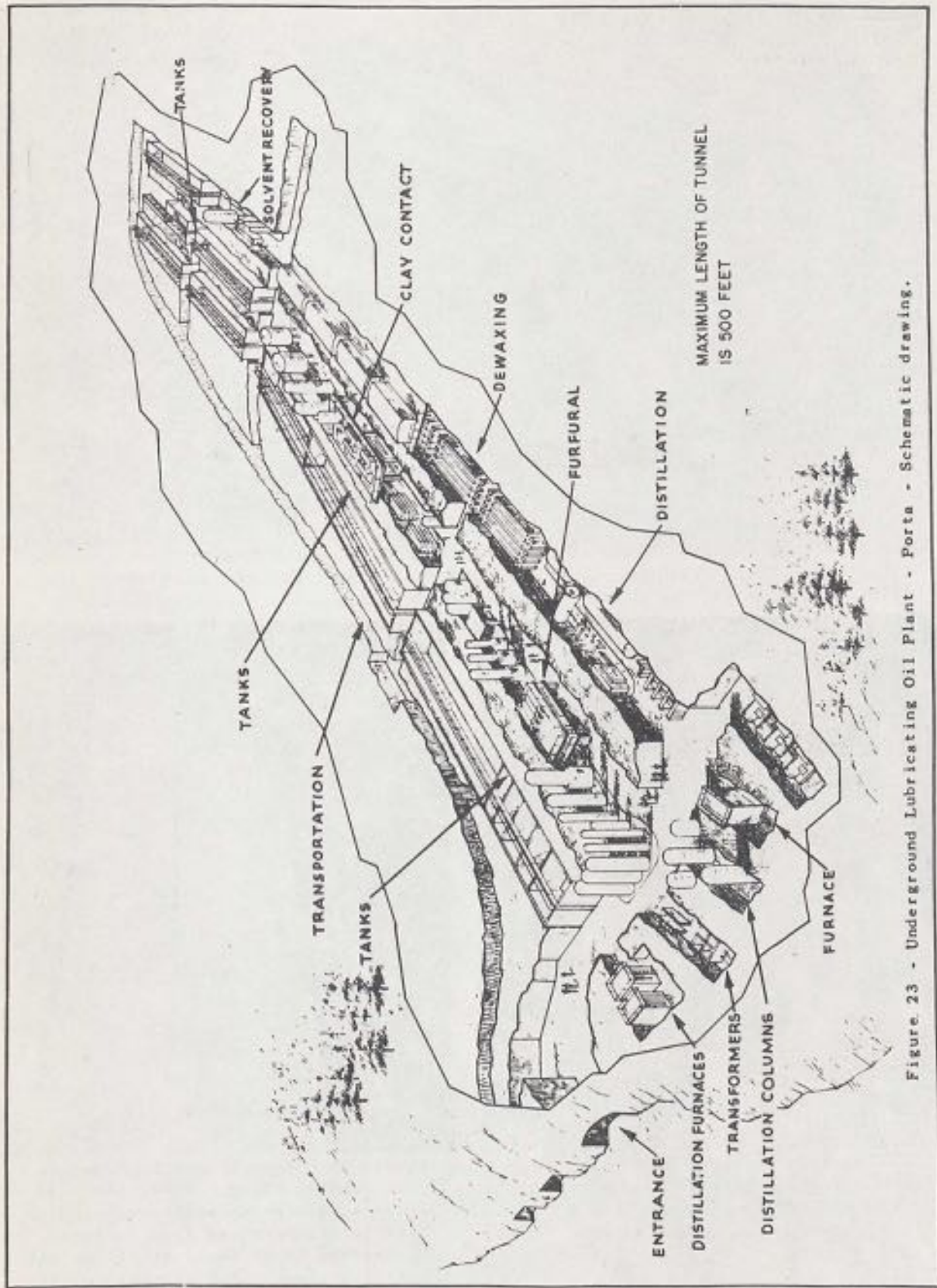

Figure 23 - Underground Lubricating Oil Plant - Porta - Schematic drawing.

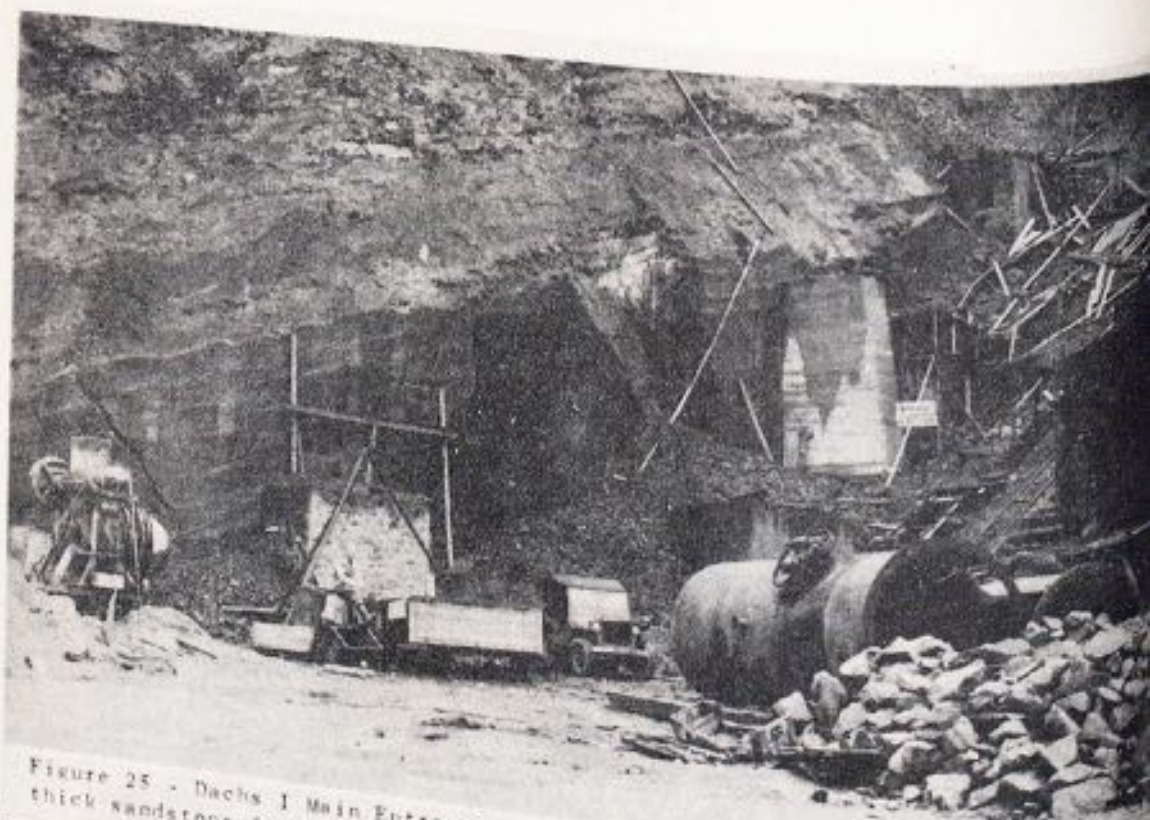

Figure 25 - Dachs I Main Entrance - All of the tunnels are cut out of a 50 foot thick sandstone formation visible in the photograph.

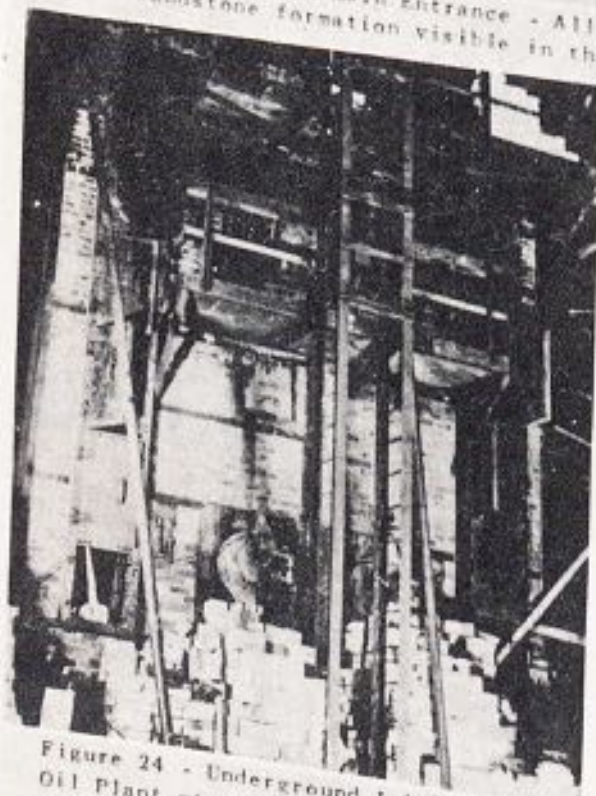

Figure 24 - Underground Lubricating Oil Plant at Porta - The furfural unit furnace was covered into a small room on the third level.

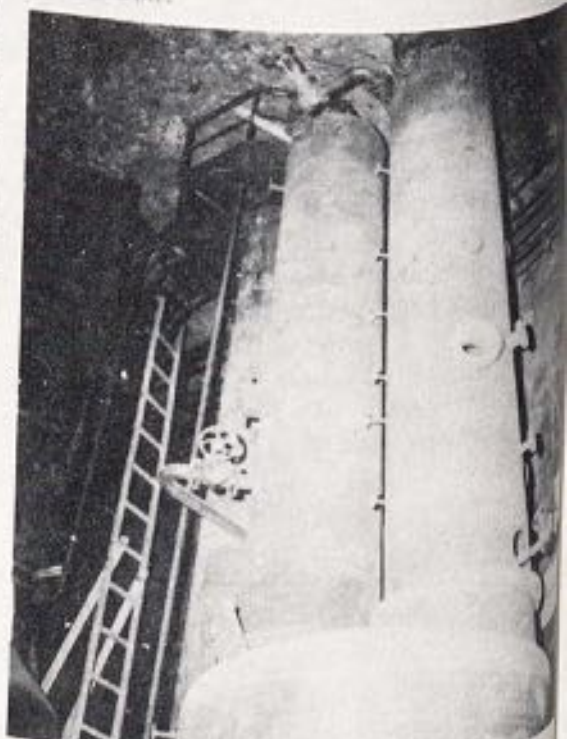

Figure 26 - Underground Lubricating Oil Plant at Porta - These two tall vessels, placed underground at Porta were to separate gas from furfural, a treating agent for lubricating oil. Note how closely the excavation fits the equipment.

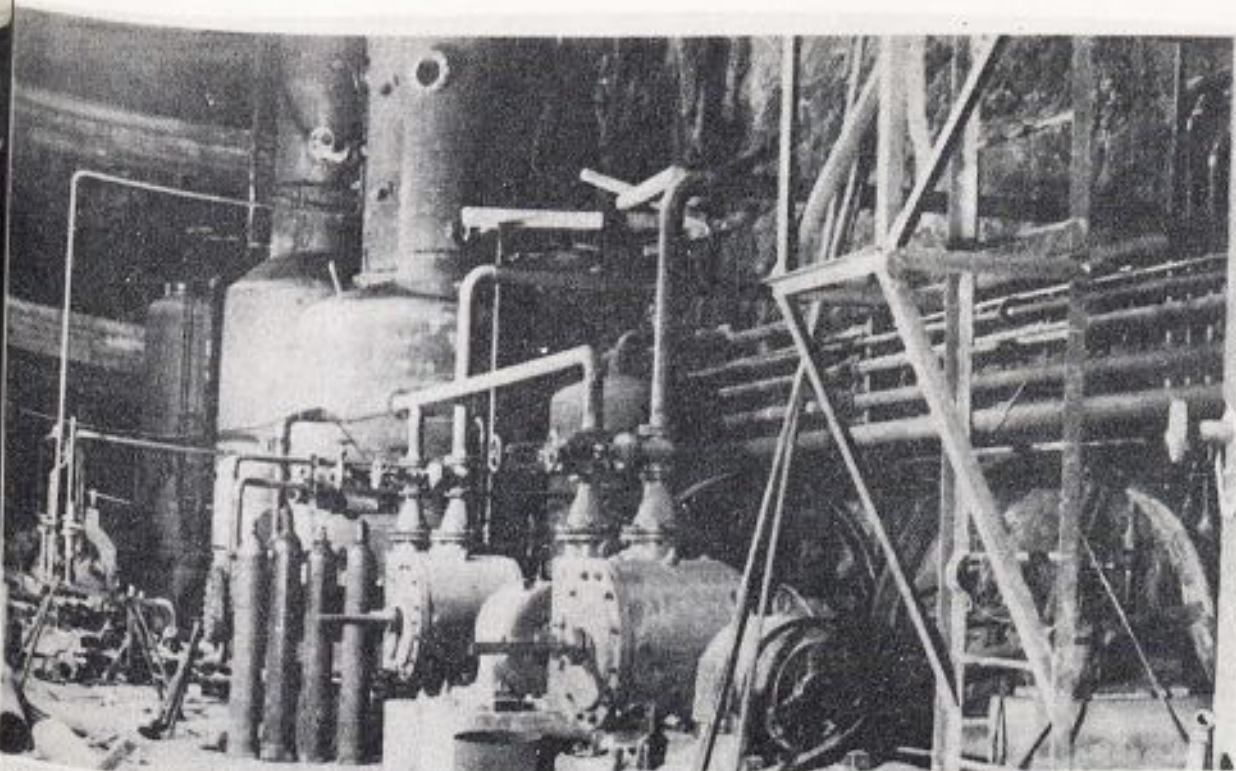

Figure 27 - The vacuum pump in the foreground of this photograph served the furfural unit, part of which is shown in the picture above. This was a three-story section of the plant, as can be seen by noting the two additional levels in the background.

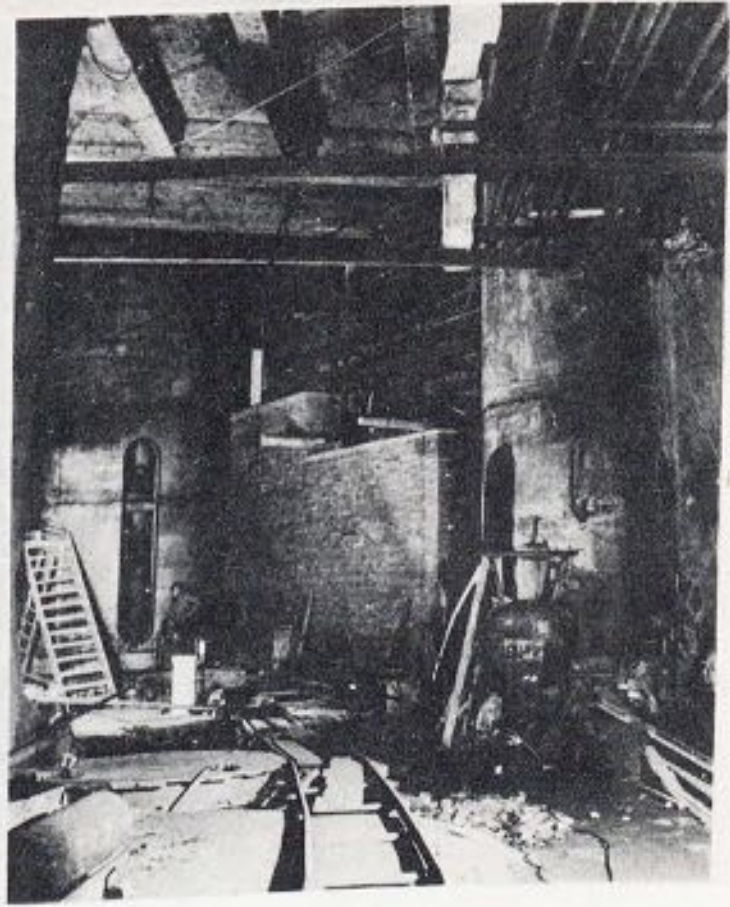

Figure 28 - Underground Lubricating Oil Plant at Porta - 46,000 cubic yards of sandstone were dug out of a cliff at the Porta Westphalica to form the tunnels housing this plant. These two vacuum distillation columns extended about 50 feet above the top of the picture.

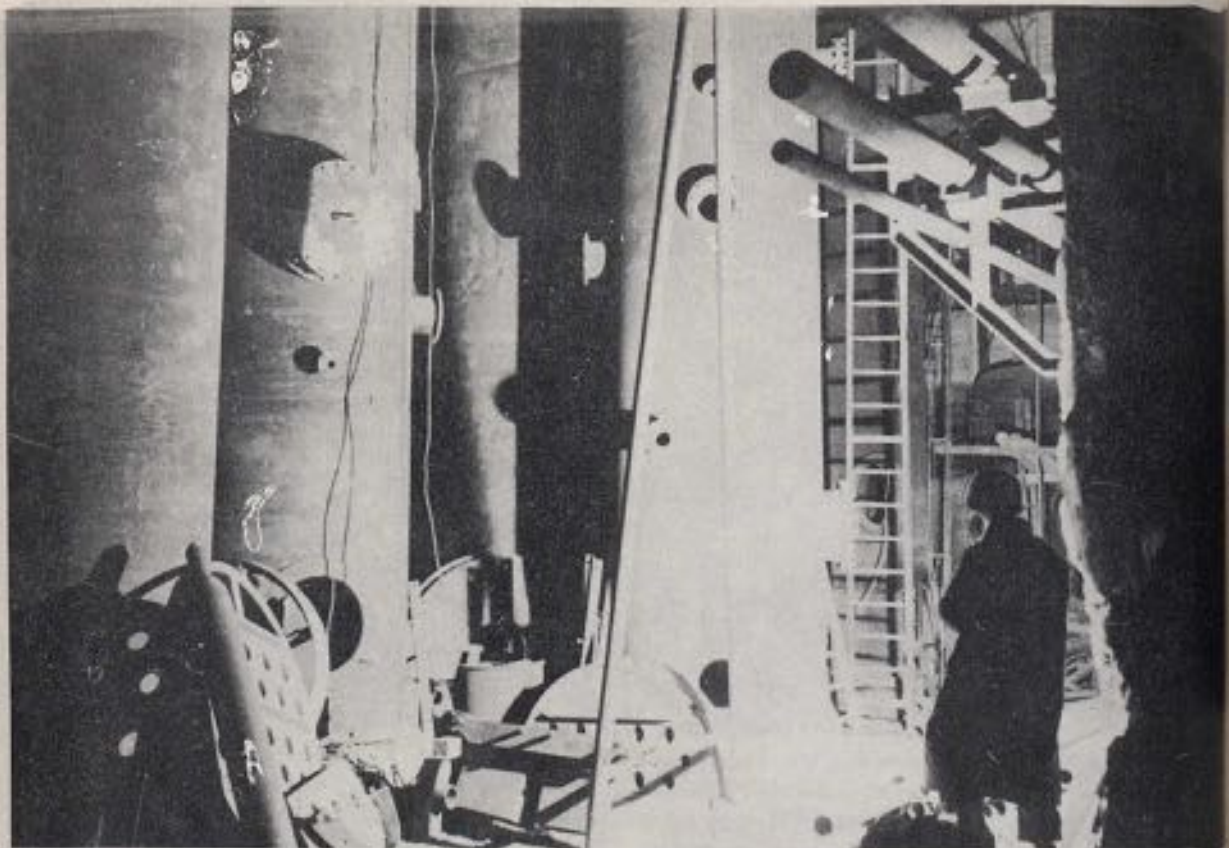

Figure 29 - The furfural unit separators and extraction columns at Porta were crowded into a narrow space in one of the tunnels. The cost of this plant was estimated at 27,000,000 RM.

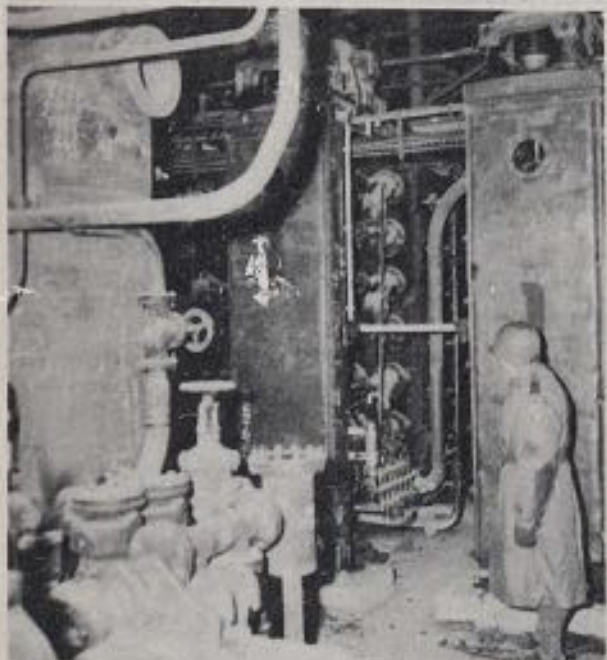

Figure 30 - Underground Lubricating Oil Plant at Porta - Oil is cooled by these dewaxing unit chillers to solidify the wax so that it can be removed by filters located on the floor above. 005

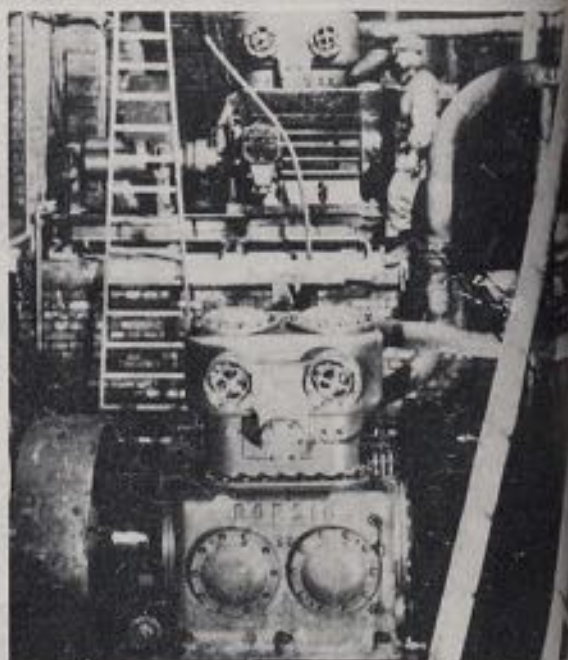

Figure 31 - These ammonia compressors are part of the refrigeration system of the waxing unit. The compressor room has an independent ventilation system because of the hazard of ammonia vapors.

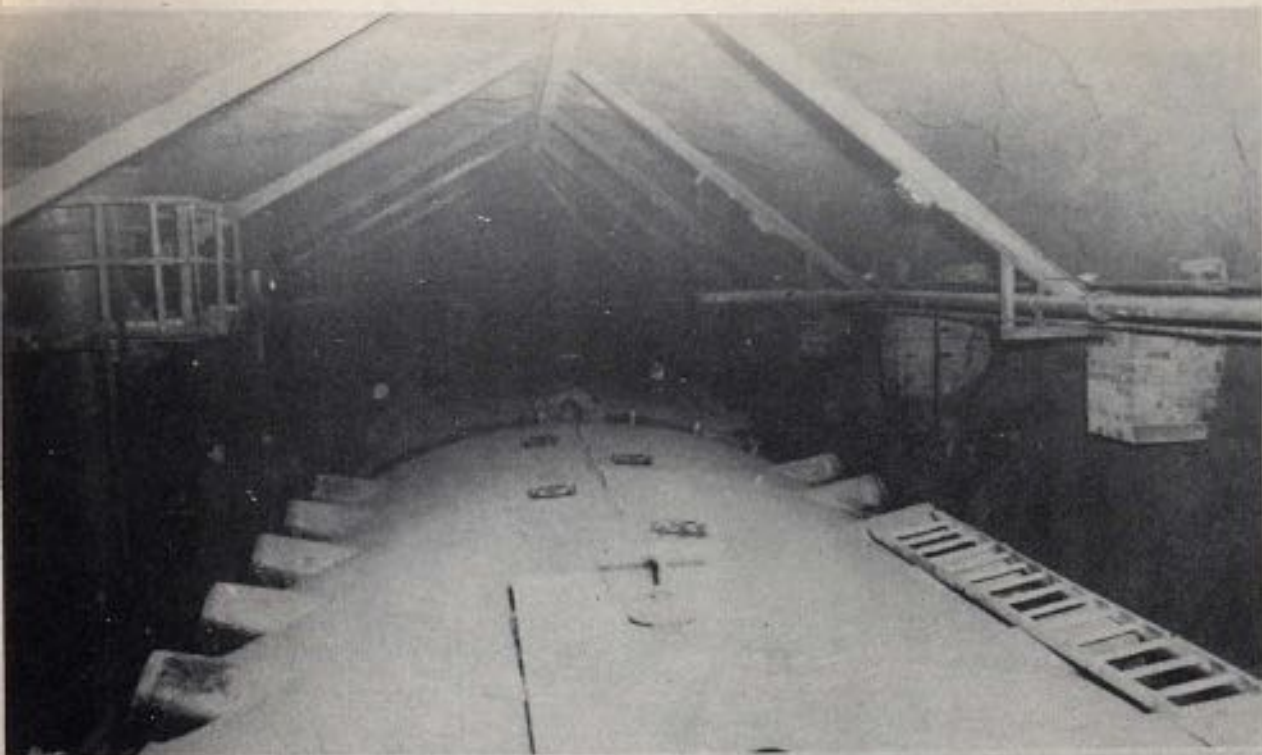
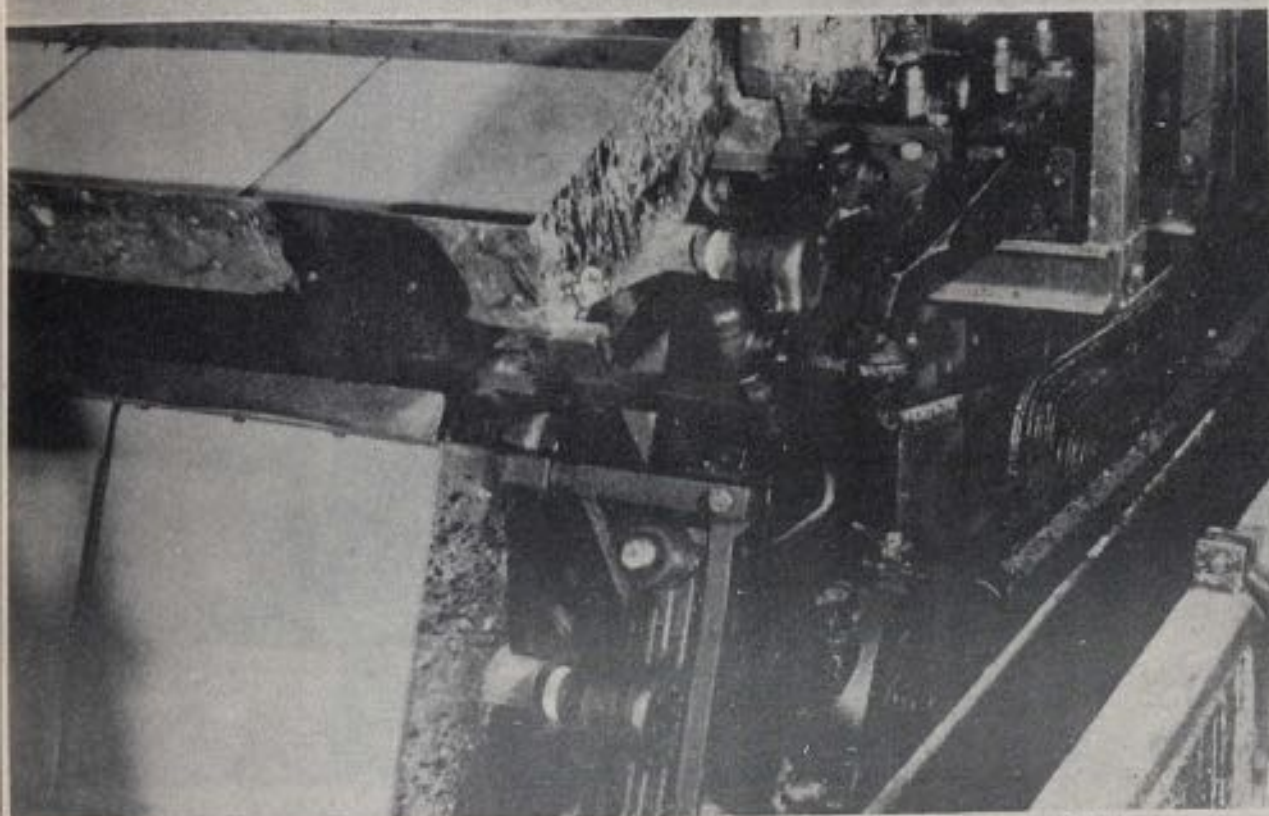

Figure 32 - Underground Lubricating Oil Plant at Porta - These large pieces of equipment were dewaxing unit filters, crowded into a tunnel of the Porta underground lubricating oil plant. These were a new type of filter, never tried before in a commercial plant.



005 Figure 33 - This photo shows the mechanism of the filters shown above. Filter trays moved on a continuous chain and vacuum was applied by means of shoes contacting a hollow rail.

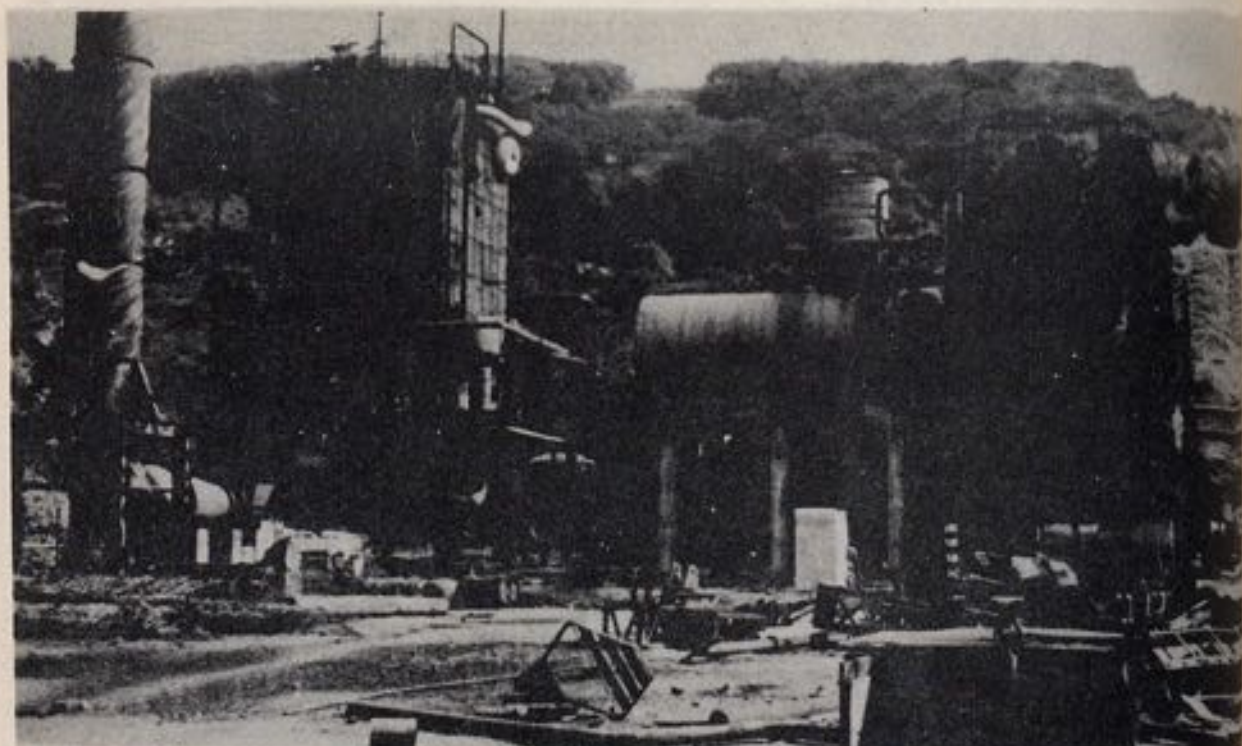

Figure 34 - Underground Lubricating Oil Plant at Porta - This boiler was erected above ground to save time. A second boiler was to be built underground after the plant was started, and this one was to be moved underground eventually.



Figure 35 - Underground Lubricating Oil Plant at Porta - The feed tanks were hidden in the woods, but the intermediate storage was underground.

LUBRICATING OILS

(Greater Germany)

COMPLETION DATES - UNDERGROUND AND DISPERSAL PLANTS

| <u>Completion Date</u> | <u>Plant</u> |
|------------------------|--------------|
| 15 May 1945 | Dachs 1 |
| 1 Aug 1945 | Dachs 2, 3 |
| 1 Sept 1945 | Dachs 7 |
| 1 Feb 1946 | Dachs 4 |
| 1 Mar 1946 | Dachs 5 |
| 1 Apr 1946 | Dachs 6 |
| 1 May 1946 | Dachs 8 |

MONTHLY AVERAGE

PLANNED CAPACITY OF UNDERGROUND AND DISPERSAL PLANTS COMPARED WITH TOTAL GERMAN PRODUCTION

LUBRICATING OILS

IN THOUSANDS OF METRIC TONS PER MONTH

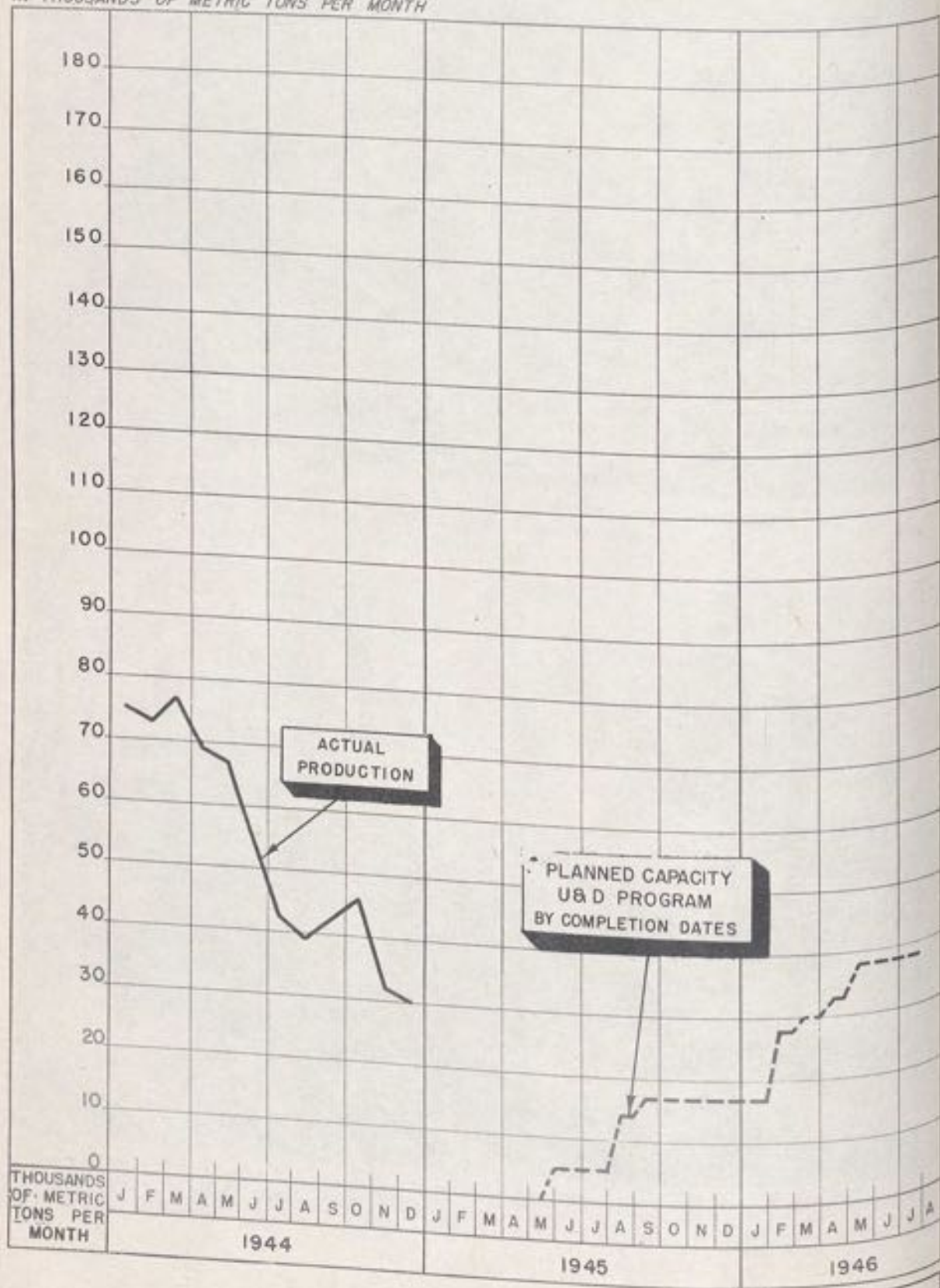

MINERAL OIL SECURITY PLAN

RESERVE PLANTS *ROST*

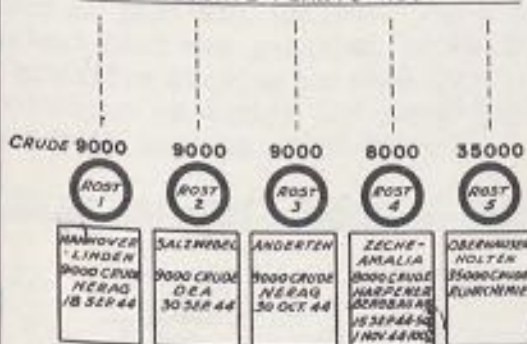

KEY TO DRAWINGS

- PROJECTED AND/OR UNDER CONSTRUCTION
- BEING PROJECTED
- ORDER:** EQUIPMENT ORIGINALLY FOR PLANT AS NOTED BUT SWITCHED TO THIS PROGRAM
- OFEN** - SMALL DISTILLATION UNIT
- ROST** - SHELL STILL
- DACHS** - LUBRICATING OIL
- TAUBE** - CRACKING PLANT

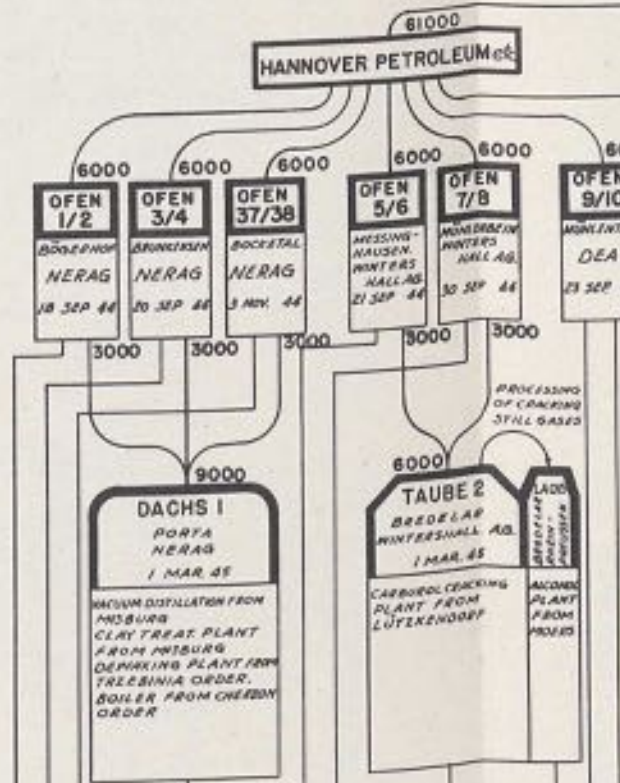

| | | | | | | |
|-----------------------|-----------|-----------|-----|-----------|-----------|-----------|
| MOTOR GASOLINE (V.V.) | 600,000 | 600,000 | | 600,000 | 600,000 | 600,000 |
| 1.5% PFT GAS | | | | 200,000 | 200,000 | |
| DIESEL FUEL (DE) | 200,000 | 200,000 | 300 | | | |
| AVIATION GASOLINE | | | | | | |
| FUEL OIL | | | | | | |
| LUBE OIL | | | | | | |
| PARAFFIN | | | | | | |
| AROMATIC RESIDUES | | | | | | |
| TOTAL | 1,000,000 | 1,000,000 | 300 | 1,000,000 | 1,000,000 | 1,000,000 |

DIESEL FUEL

Diesel fuel was produced primarily by the crude oil refineries and the distillation units of the dispersal program, but late in 1944 it was decided to produce Diesel oil from the middle oil from low-temperature carbonization plants (code name MOLCH). This was to be accomplished by extracting the undesirable phenols and cresols with methanol leaving an oil which could be converted to a marketable Diesel oil with a simple distillation. Normally, the middle oil had been hydrogenated, in which process the phenols are destroyed, but the destruction of hydrogenation plants had resulted in a backlog of this product.

In addition, primitive units, called WUESTE were built for the extraction of oil from shale. The shale was piled about 10 feet high, covered with a layer of peat and ignited. As a result of partial combustion, sufficient heat was produced to crack oil vapors out of the shale. (See schematic drawing on page 49). These vapors were condensed for the production of a very low grade Diesel fuel which could only be used in hot bulb engines (semi-Diesel).

DIESEL OIL CAPACITY - DISPERSAL PROGRAM

| | | Capacity <u>T/Mo.</u> | <u>Status</u> |
|----------------------------------|---|--------------------------|--|
| Molch 1 | 1 | 6,000 | Nearly completed. |
| (Phenol | 2 | 4,400 | Nearly completed. |
| Extraction | 3 | 2,100 | Completed. |
| | 4 | 3,900 | To be finished 30 June, 1945. |
| | 5 | 2,000 | |
| | 6 | 1,700 | To be completed 15 June, 1945. |
| Wueste 2, 4, 8 and 9 | | 7,200 | In makeshift production. |
| (Shale 1 | | 1,800 | Ready for makeshift production in June, 1945. |
| Oil) 3, 5, 6, 7, 10 | | <u>9,000</u> | Postponed - 3 months to complete. |
| | | 38,100 | |
| By products from other plants | | <u>120,900</u> | |
| TOTAL | | 159,000 | |

The above production of Diesel fuel would be reduced to 103,000 tons per month by the necessity for providing Diesel oil for feed to the catalytic cracking units and one of the hydrogenation plants.

Figure 41 page 51 shows the planned capacity of the dispersal program for the production of Diesel oil as well as total German Diesel oil production for 1944.

The cost of the Phenol extraction and shale oil plants was approximately 70,000,000 RM. or about 10,000 man years of labor.

The cost of the Phenol extraction and shale oil plants was approximately 70,000,000 RM. or about 10,000 man years of labor.

The cost of the Phenol extraction and shale oil plants was approximately 70,000,000 RM. or about 10,000 man years of labor.

Summary of Costs - Within the Plant

| Category | Cost (RM) |
|--------------------|------------|
| Construction | 50,000,000 |
| Equipment | 15,000,000 |
| Installation | 5,000,000 |
| Operating Expenses | 10,000,000 |
| Reserve | 5,000,000 |
| Total | 85,000,000 |

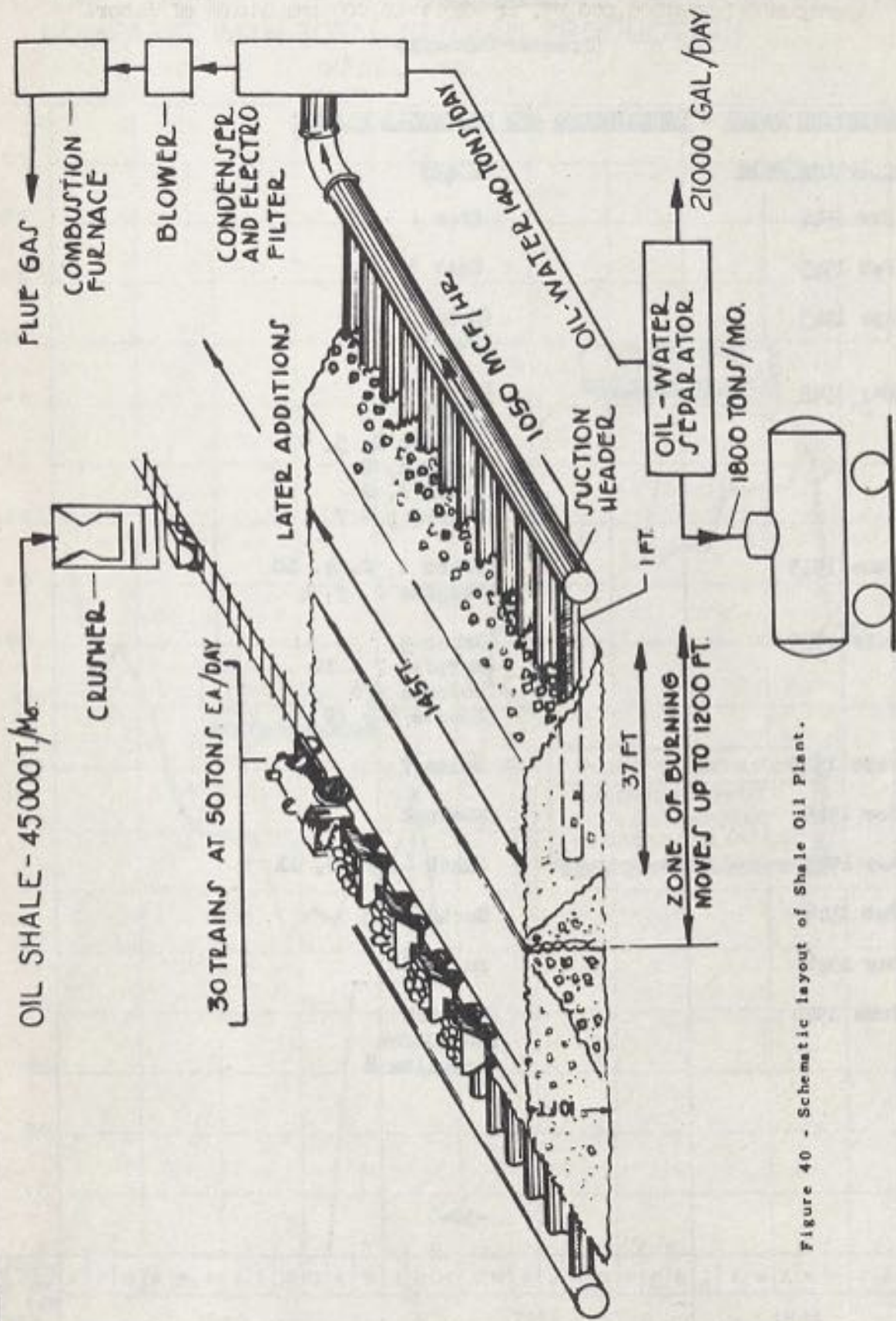

Figure 40 - Schematic layout of Shale Oil Plant.

DIESEL OIL

(Greater Germany)

COMPLETION DATES - UNDERGROUND AND DISPERSAL PLANTS

| <u>Completion Date</u> | <u>Plant</u> |
|------------------------|--|
| 1 Nov 1944 | Ofen 1 - 38 |
| 1 Feb 1945 | Rost 1 - 5 |
| 1 Apr 1945 | (Molch 3 (Wueste 1 - 4 |
| 1 May 1945 | (Dachs 1 (Jakob 3, 9 (Karpfen 1, 5, 6 (Molch 1, 2 (Taube 1, 2 (Wueste 5 - 7 |
| 1 June 1945 | (Jakob 1, 2, 4, 10 (Karpfen 2, 3, 4 |
| 1 July 1945 | (Jakob 5 (Karpfen 7 - 10 (Molch 4 - 6 (Wueste 8 - 10 |
| 1 Sept 1945 | Dachs 7 |
| 1 Nov 1945 | Kuckuck |
| 1 Dec 1945 | Jakob 6, 7, 8, 11 |
| 1 Feb 1946 | Dachs 4, 5 |
| 1 May 1946 | Dachs 8 |
| 1 June 1946 | (Kranich (Kugelofen (Schwalbe 8 |

MONTHLY AVERAGE
**PLANNED CAPACITY OF UNDERGROUND AND DISPERSAL PLANTS
 COMPARED WITH TOTAL GERMAN PRODUCTION**
 DIESEL OIL

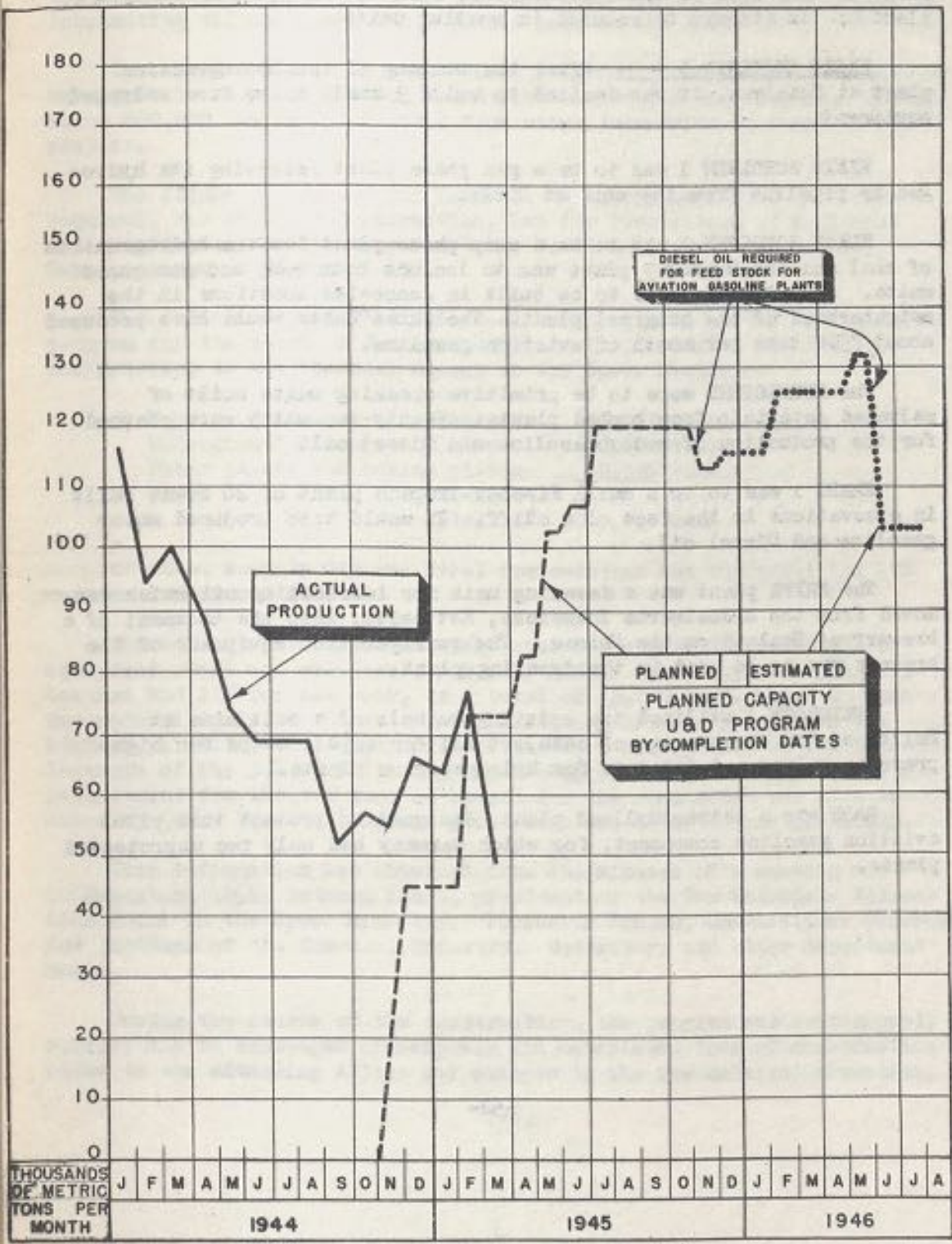

FIGURE 41

MISCELLANEOUS PLANTS

In addition to the above units which were part of an integrated program, there were a number of dispersal plants which apparently were built to take care of local conditions, such as the destruction of a plant as an attempt to rebuild in smaller units.

KLEIN SCHOLVEN 1 - 3: After the bombing of the hydrogenation plant at Scholven, it was decided to build 3 small units from salvaged equipment.

KLEIN SCHOLVEN 1 was to be a gas phase plant receiving its hydrogen by pipeline from the unit at Huels.

KLEIN SCHOLVEN 2 was to be a sump phase plant for the hydrogenation of coal and the Number 3 plant was to include both sump and gas phase units. All of these were to be built in concealed locations in the neighborhood of the original plant. The three units would have produced about 7500 tons per month of aviation gasoline.

The KUGELOFENS were to be primitive cracking units built of salvaged materials from bombed plants. Twenty-two units were planned for the production of motor gasoline and Diesel oil.

KREBS 1 was to be a small Fischer-Tropsch plant of 20 ovens built in excavations in the face of a cliff. It would have produced motor gasoline and Diesel oil.

The FRITZ plant was a dewaxing unit for lubricating oil which was moved from the Erdoelwerke Idaweiche, Kattowitz, into the basement of a brewery at Neuland on the Neisse. The refrigeration equipment of the brewery was to be used in the dewaxing plant.

STEINBOCK 1 utilized the existing tunnels of a salt mine at Heilbronn for the storage of catalyst and for repair shops for high-pressure valves and fittings for hydrogenation plants.

RABE was a tetraethyllead plant, designed to protect this vital aviation gasoline component, for which Germany had only two unprotected plants.

COST AND MANPOWER FOR THE ENTIRE PROGRAM

The entire program of underground and dispersal plants for the oil industry consisted of about 140 individual plants ranging in size from the small distillation units to the large and complicated hydrogenation, lubricating oil and combination plants such as the KUCKUCK.

The estimated cost of this entire program as originally laid out was approximately 1.4 billion Reichsmarks and would have required taking about 200,000 man years of labor from other industries to complete the project.

The figure of 200,000 man years is an approximation of the labor required, not only for construction, but for fabrication of equipment and supplies so that it represents the total manpower drain on the German economy. (See page 67).

The following quantities of steel were required by the Geilenberg program for the month of January, 1945, as outlined in a requisition for priority to the Planning Agency of the Speer Ministry:

| | |
|--------------------------------|--------------------|
| Repair of damaged oil plants | 30,000 tons |
| Underground dispersal plants | 60,000 tons |
| Tower plants and coking plants | <u>10,000 tons</u> |
| Total | 100,000 tons |

Of this, roughly 60% was steel for machines and equipment and 40% was for structural steel.

The new top priority (V-R) requested was apparently reserved for equipment steel and was issued for only 40% of that requested for maintenance and 20% for new work, or a total of 15,000 tons, which in turn was reduced to 14,000 tons. Since Geilenberg had always enjoyed the highest priority, this apparently indicates a recognition of the hopelessness of the job of finishing the underground plants. Geilenberg's requirement for 160,000 tons of cement for the same month was also reduced by 50%. The total German production was 400,000 tons per month.

This information was obtained from the minutes of a meeting on 20 December, 1944, between Kehrl, president of the Raw Materials Allocation Board in the Speer Ministry. Professor Krauch, Commissioner General for problems of the Chemical Industry. Geilenberg and other department heads.

During the course of the construction, the program was continuously revised due to shortages of manpower and materials, loss of construction sites to the advancing Allies and changes in the raw material situation.

The following major plants were dropped before the end of the war:

| | |
|---------------------------|--------------------|
| Dachs 5, 6, 8 | Lubricating oil |
| Schwalbe 2, 3, 4, 6, 7, 8 | Hydrogenation |
| Jakob 6, 7, 8 | Cracking |
| Iltis 2, 3 | Superfractionation |

These changes, to a large extent, were made because it was evident that the plants could not be built in time to influence the course of the war and because of shortages of materials and labor.

The abandonment of these plants reduced the overall cost of the program to approximately, 690,000,000 RM. or 50% of the original plan.

A memorandum dated 25 October, 1944, covering a discussion between Director Simmat and Dr. Sauer (Krauch's office) developed the following points with reference to underground and dispersal plants:

1. If the hydrogenation plants had been built in small units consisting of one coal unit instead of concentrated groups of units like the plant at Gelsenberg, the cost in labor, material and time would have been as follows (in percent of the requirement for the large plant):

| | |
|------------------------|---------------------|
| Materials | 125% |
| Labor | 125 to 150% or more |
| Period of construction | 150 to 200% |
| Operating personnel | 200% |

2. If large units were constructed underground:

| | |
|------------------------|------------|
| Materials | 90% |
| Labor | 100 - 110% |
| Period of construction | 150 - 200% |
| Operating personnel | 100% |

The statement is made that materials are reduced because of the more compact design and elimination of buildings and air raid shelters. Practically all of the underground plants were built in solid rock so that concrete linings were necessary. It was pointed out that originally the underground plants were expected to require more material but experience indicated otherwise.

The figure of 100 to 110% for labor on underground plants seems unreasonably low to the writers, as the cost of buildings eliminated can hardly be as great as the cost of excavation. It is possible that the comparison is being made with a surface plant in which the work is seriously disrupted by air raids. In this case, labor might well be 150% of normal. It was pointed out, however, that a substantial part of the labor consists of miners and that they had been a major bottleneck for some time.

Professor Krauch, Commissioner General for Problems of the Chemical Industry (Geschem), estimated the overall effort expended on underground plants to be three times that for surface plants of equal size.

The conclusion reached by this memorandum was that the oil industry would have been worse off if it had attempted to disperse or go underground in 1937. This was an attempt, however, to justify a program which had failed and was undoubtedly colored by that fact. Considering the tremendous amount of labor and material that was expended on repairing bomb damage to oil plants, it is almost self-evident that had this effort been expended earlier on construction of carefully planned underground plants, the oil industry would have been in a much better position.

A note included in Krauch's file estimates a cost of six-billion RM for complete protection of 14 oil plants (probably mainly hydrogenation) and 4 Buna plants and places the labor required at 1,200,000 man years. It is not possible to compare these figures directly with the total cost of the underground and dispersal program, but they do confirm that the ratio of man hours to cost used by the writers is on the conservative side.

Dr. Fritz Ringer, head of the mineral Oil Bureau under Dr. Butefisch, stated that the underground plants could not have been completed in time to influence the amount of fuel available for war. The great struggle put up by Geilenberg to fulfill this program represents, therefore, an application of manpower at the wrong spot. The following is an extract from an interrogation of Professor Krauch, Commissioner General for Problems of the Chemical Industry:

"The construction of almost all plants of the chemical production plan, except for powder and explosives, should have been possible as private enterprise, even where the slightly increased production costs due to war conditions required certain guarantees by the Government. For the underground construction, with considerably more expensive methods, private enterprise was out of the question. This is the reason why the SS was chosen for the construction, and in some cases, for the operation of certain underground plants. Only the SS had the necessary manpower and was able to guarantee completion dates in view of the difficult economic developments. The SS had the most experience in the building of underground space, as they had participated in the installation of underground plants for the aircraft industries and V-bomb production."

ESTIMATED COSTS AND LABOR REQUIRED
UNDERGROUND & DISPERSAL PROGRAM
OIL INDUSTRY

| <u>Plant</u> | | <u>Estimated Total Cost of Plant in RM</u> | <u>Cost of Plant to End of War in RM</u> | <u>Total Labor Man Days</u> |
|------------------------|---|--|--|---------------------------------|
| <u>AVIATION FUEL</u> | | | | |
| Schwalbe | 1 | 150,000,000 | 85,000,000 | 6,750,000 |
| | 2 | 110,000,000 | 1,000,000 | 4,950,000 |
| (Hydro | 3 | 110,000,000 | 1,000,000 | 4,950,000 |
| genation) | 4 | 110,000,000 | 1,500,000 | 4,950,000 |
| | 5 | 110,000,000 | 30,000,000 | 4,950,000 |
| | 6 | 110,000,000* | 100,000* | 4,950,000* |
| | 7 | 110,000,000* | 100,000* | 4,950,000* |
| | 8 | 110,000,000* | 100,000* | 4,950,000* |
| Kuckuck | | 150,000,000 | 70,000,000 | 6,150,000 |
| Kybol | 1 | 1,000,000 | 1,000,000 | 45,000 |
| (Di-ethyl | 2 | 1,000,000* | 50,000* | 45,000* |
| Benzene | | | | |
| Fasan | 1 | 1,000,000* | 400,000* | 45,000* |
| (Mixed | 2 | 1,000,000* | 100,000* | 45,000* |
| Benzenes) | | | | |
| Iltis | 1 | 800,000 | 400,000 | 36,000 |
| (Super- | 2 | 800,000* | 100,000* | 36,000* |
| fraction- | 3 | <u>800,000*</u> | <u>100,000*</u> | <u>36,000*</u> |
| ation) | | | | |
| TOTAL | | 1,076,400,000 | 190,950,000 | 47,838,000 |
| <u>LUBRICATING OIL</u> | | | | |
| Dachs | 1 | 27,000,000 | 26,000,000 | 1,220,000 |
| (Lube | 2 | 40,000,000 | 30,000,000 | 1,800,000 |
| Oil) | 3 | 9,000,000 | 4,500,000 | 405,000 |
| | 4 | 40,000,000 | 10,000,000 | 1,800,000 |
| | 5 | 20,000,000* | 500,000* | 900,000* |
| | 6 | 10,000,000* | 100,000* | 450,000* |
| | 7 | 8,000,000 | 6,000,000 | 320,000 |
| | 8 | 12,000,000* | 100,000* | 540,000* |
| Steinbock | 2 | <u>3,000,000</u> | <u>300,000</u> | <u>135,000</u> |
| (Parafflow) | | | | |
| TOTAL | | 169,000,000 | 77,500,000 | 7,570,000 |

*Estimated by the writers.

ESTIMATED COSTS AND LABOR REQUIRED - cont'd

| | | <u>MOTOR FUEL</u> | | |
|--------------|------|-------------------|-----------------|----------------|
| Ofen | 1-40 | 30,000,000 | 30,000,000 | 1,350,000 |
| Crude | | | | |
| Distillation | | | | |
| Rost | 1-5 | 4,200,000 | 4,200,000 | 189,000 |
| Crude | | | | |
| Distillation | | | | |
| Taube | 1 | 14,000,000 | 12,000,000 | 630,000 |
| Cracking | 2 | 4,000,000 | 3,800,000 | 180,000 |
| | | | | |
| Karpfen | 1-10 | 12,000,000 | 7,000,000 | 540,000 |
| Fischer | | | | |
| Synthesis | | | | |
| Jakob | 1 | 1,900,000 | 700,000 | 85,000 |
| Cracking | 2 | 1,900,000 | 900,000 | 85,000 |
| | 3 | 1,900,000 | 1,800,000 | 86,000 |
| | 4 | 1,900,000 | 1,100,000 | 85,000 |
| | 5 | 1,900,000 | 1,100,000 | 85,000 |
| | 6 | 1,900,000* | 100,000* | 85,000* |
| | 7 | 1,900,000* | 100,000* | 85,000* |
| | 8 | 1,900,000* | 100,000* | 85,000* |
| | 9 | 1,000,000 | 700,000 | 50,000 |
| | 10 | 1,900,000 | 600,000 | 85,000 |
| | 11 | <u>1,900,000</u> | <u>700,000*</u> | <u>85,000*</u> |
| | | | | |
| TOTAL | | 84,200,000 | 64,900,000 | 3,790,000 |

| | | <u>DIESEL OIL</u> | | |
|------------|------|----------------------|--------------------|-------------------|
| Molch | 1 | 3,500,000 | 3,000,000 | 158,000 |
| Phenol | 2 | 4,000,000 | 3,000,000 | 180,000 |
| Extraction | 3 | 3,000,000 | 3,000,000 | 135,000 |
| | 4 | 4,500,000 | 2,700,000 | 202,000 |
| | 5 | 3,000,000* | 2,500,000* | 135,000* |
| | 6 | 3,000,000 | 2,000,000 | 135,000 |
| | | | | |
| Wuest 1 | 1-10 | <u>48,000,000</u> | <u>36,000,000</u> | <u>2,160,000</u> |
| Shale Oil | | | | |
| TOTAL | | 69,000,000 | 52,200,000 | 3,105,000 |
| | | | | |
| GRAND | | | | |
| TOTAL | | <u>1,398,600,000</u> | <u>385,550,000</u> | <u>62,303,000</u> |

*Estimated by the writers.

THE UNDERGROUND OIL PLANT IN PRACTICE

It is the belief of the writers that operation of underground oil plants is technically feasible, and that given proper design and ventilation they can be operated with reasonable safety. It is true that certain modifications of design would be desirable to reduce leakage, especially in the case of water gas generators for hydrogen, but this is only a matter of engineering and there do not appear to be any problems that cannot be solved.

Professor Krauch, Commissioner General for problems of the Chemical Industry, within Speer Ministry for Armament and War Production, did not believe it feasible to put the large hydrogenation plants underground. On the other hand, Director Von Felbert, manager of the Brabag coal hydrogenation plant at Boehlen and in charge of the underground hydrogenation plant program, was enthusiastic about its possibilities. He was fully conversant with the hydrogenation plant problems involved from his own experience and believed that they could all be solved.

The underground oil plant will inevitably be more hazardous both to plant and personnel in case of a serious leak or fire, but it would certainly be safer than a plant which is being bombed periodically. A small fraction of the effort expended on rebuilding damaged plants, if devoted to inspection and maintenance of underground units would almost preclude serious leaks which might lead to underground explosions or serious fires. Minor leaks can be handled satisfactorily by a ventilating system which provides five to ten changes of air per hour. The KUCKUCK plant used as high as 40 changes per hour in the hydroforming unit. As a matter of fact, ventilation of these tunnels is comparatively simple and the only limit is the amount of wind that the operators can stand.

There are, however, a number of weaknesses in the underground and dispersal program as worked out by the German oil industry. It must be emphasized that this was a program carried out on the spur of the moment, as no serious plans had been made in previous years. A number of technical men were found who claimed to have suggested moving underground as early as 1940, but they were threatened with concentration camps and told that the war would be over before the plants could be built. When the necessity for dispersal was finally recognized, the problem was attacked with great haste. As an example, an I. G. Farben file was found containing some fifty drawings and studies of underground hydrogenation plants, rushed out within a month.

Assuming that an oil refinery is installed satisfactorily underground so that it is properly protected, the underground and dispersal program was still weak in transportation, storage and utilities.

Transportation is the greatest weakness of this program since the German railroads were virtually at a standstill as a result of air raids toward the end of the war. Thirty-eight small crude distillation units, OFENS, were dispersed throughout Germany and as indicated in the table page 105, less than forty per cent of this capacity was used, primarily because of lack of transportation. The dispersal program itself was a contributing factor to the general transportation problem at a time when transportation was most critical. The plants were scattered many miles apart and in nearly all cases were entirely dependent on the railroads for supply of raw materials and distribution of finished products.

Lack of storage was another weakness of these plants. They were set up to work with maximum inventories of approximately four days' feed stock and one to two days' production. Naturally, with transportation upset, this led to serious loss of capacity. These restrictions were set, not from any reluctance to invest in tankage, but from experience with existing refineries where the greatest damage was done to tankage and stocks and every attempt was made to reduce inventories to a minimum.

Utilities were also a vulnerable spot in the dispersal program. In order to reduce transportation of coal to a minimum, and to save time required for additional excavation, these plants depended almost entirely on outside electric power for their operations. Power cables and transformers were underground, but destruction of local high-voltage networks or power stations would have stopped operations. Plans were under way to equip some units with underground standby electric power plants to handle about 40% of normal capacity, but these would have had to come later because of the bottleneck in production of electrical machinery.

Steam plants could be and were being located underground and here the only problem was fuel. This was, however, not a simple problem as fuel involved transportation.

In many cases, the plants were set up to burn their own residuum, extracts and fuel gas, but usually either coal or fuel gas was required from outside.

Water supply was not too serious a problem as the pumps are relatively small and can be installed underground or in bombproof shelters.

Feed stocks for the lubricating oil plants could probably be made available if the transportation problem could be solved. Feed for the underground aviation fuel plants was another matter. In these cases, only the gas phase hydrogenation plants were to go underground and they were to be fed tar from existing sump phase or coal hydrogenation plants and plants for the carbonization of Brown Coal and other coals. Since

these plants are quite large and must be located near the coal deposits for practical operation, it was not intended that they should be located underground. Hence, to nearly eliminate aviation gasoline production, it would only be necessary to keep a relatively small number of coal hydrogenation and carbonization plants out of operation by bombing.

It may be said that the underground and dispersal plans for the oil industry were impractical as set up hurriedly in the Summer of 1944, and carried out at great cost in manpower and materials during the Fall and Winter. It was definitely a case of "too little, and too late". This was admitted by Geilenberg, who also claims to have told Goering in October, 1944, that the situation in the entire oil industry was hopeless unless sufficient fighters could be put into the air to protect the existing refineries.

This does not mean that operation of an oil industry underground is impossible, but only that work was started too late and with insufficient planning. When dispersal was started, it was done too hastily, without sufficient thought to transportation, and the program as laid out would probably not have been successful even if it had come into operation.

It is the opinion of the writers that with proper planning of centralized underground plants (rather than dispersed plants) and a program started between one and two years earlier, the oil industry might have been able to maintain a respectable production in spite of bombing. This would have involved two or three large underground refineries, near the German oil fields in Hannover and the Danube areas. In addition, several large underground coal hydrogenation and carbonization plants would be needed near the coal deposits. These large refineries could easily be subdivided by splitting them up into separate tunnels so that an accident to one would not affect the others.

This program would necessarily include crude oil pipelines from the fields to the refineries and a network of product lines for distribution. Distances within Germany are not too great and the steel that went into replacement of bomb damage probably would have been sufficient to cover the pipelines required.

With coal hydrogenation and carbonization underground, it might even be possible to supply fuel gas from coal carbonization plants to these refineries to cut down the transportation of coal. To be sure, this would require a large expenditure of materials and manpower, but it would probably be less than that already expended on repairs plus dispersal.

Complete safety would require stand-by electric power or further protection of the electric industry, either of which is probably feasible.

Due to the late start, the underground oil program had very little effect on the course of the war. Some straight-run gasoline and Diesel oils and a small amount of di-ethyl-benzene were produced for motor fuel but that was all.

Total Production of OFENS - November 1944 Through February 1945

| | <u>Total</u> | <u>Average Tons per Month</u> |
|-------------------------|--------------|-----------------------------------|
| Crude fed | 168,800 Tons | 42,200 |
| Motor gasoline produced | 17,000 Tons | 4,200 |
| Diesel oil produced | 68,000 Tons | 17,000 |

Compared with a normal motor gasoline consumption of 120,000 tons per month, it can be seen that the actual contribution of the dispersal program was quite small.

In addition, some production was obtained from the ROSTIS or shell stills. Data on these plants is incomplete, but it is almost certain that production was less than one-half of that shown for the OFENS.

The OFENS and ROSTIS were relatively safe from bombing because of their dispersal and small size, but they could not be operated effectively because of lack of transportation.

In attempting to solve the problem of protecting the oil industry, the Germans used a number of schemes which may be roughly divided into "Dispersal" and "Underground" projects.

The best example of dispersal is found in the OFEN series, of which 38 units were completed in 16 different locations. The OFENS were usually built in pairs in abandoned quarries, in valleys and woods and were heavily camouflaged. The two units of a pair were often separated a considerable distance to further increase the dispersal.

Loading racks and tanks were covered with netting and were pretty well scattered around the plant itself.

Also in the dispersal class are the TAUBE or cracking plants. One was built in the woods near Bredelar and the other along the face of a cliff near Deggendorf. The woods offered excellent concealment for some of these plants, but it was expected that the vegetation would be killed eventually by the presence of the plants.

The following plants were also in this hidden category, primarily because they were relatively small and could be hidden more easily than the hydrogenation and lubricating oil plants:

| | |
|-----------|--------------------------------|
| MOLCH | - Phenol extraction plants. |
| JAKOB | - Small cracking plants. |
| ROST | - Crude distillation units. |
| KARPFEN | - Small Fischer-Tropsch units. |
| KUGELOFEN | - Light cracking unit. |

The WUESTE consisted mainly of a large pile of burning shale with a relatively small amount of equipment which could be concealed easily.

The DACHS (lubricating oil), SCHWALBE (hydrogenation) and KUCKUCK (aviation gasoline) were to be installed underground because it was not possible to break them up into small units. In some cases, existing tunnels were enlarged, abandoned railroad tunnels were used and new tunnels were dug. Tunneling was restricted to the softer materials such as shale, limestone and gypsum, because of shortage of explosives and labor.

Another type of protection is exemplified by the large concrete vault at Muehldorf. See photographs on page 64. These vaults were roughly semi-circular in cross-section, 135 feet high and 220 feet wide inside. They were to be built up to 1200 feet long and the concrete was to be 16 feet thick.

Wooden formwork was not feasible because it could be easily destroyed by air attack before the concrete could be poured. These vaults were therefore located in deep gravel beds and gravel was piled up as a substitute for formwork. First, a concrete tunnel was built that would accommodate a train of gravel cars and gravel was piled over the top of this tunnel as a form for the concrete construction. Next, a three-inch layer of concrete was poured over the top of this gravel pile in order to seal it. Reinforcing steel was then set and the concrete was poured in two or three layers to obtain the final thickness of 16 feet. A large central concrete mixing plant was set up and all of the concrete was pumped through temporary pipelines. The structure was about 600 feet long when work was stopped, but there was about an additional 600 feet of gravel pile prepared for further extension.

Construction of the vault started in March, 1944. After the concrete work was finished, cars were run into the small tunnel in the center, hoppers were opened and the gravel above was drained out and carried away. This provided room for the operation of steam shovels to handle the balance of the gravel and relatively little labor was necessary for this project. The gravel that was moved from inside of the vault was to be piled over the top and along the sides to provide additional protection. Over this was to be placed a layer of earth planted with blackberry bushes and small trees for camouflage. By these means it was hoped to prevent detection by radar.

The vault at Muehldorf (code name WEINGUT, literally "vineyard") was originally intended to house a factory for production of Messerschmidt 262 jet-propelled fighter planes and was to contain eight floors when finished.

In the fall of 1944, it was decided to install a Buna rubber plant instead (code name ECKSTEIN). This plant was to occupy the first 400 feet of the vault and was to have a capacity of 1000 tons per month of Buna rubber with provision for further expansion to 2000 tons per month. The middle section of the vault was to contain an ammonia plant of 1000 tons-per month capacity and a tire factory was to be installed in the rear.

Other vaults of this general type were presumably under construction in the following locations:

- Watten : Linde plant for liquid oxygen.
- Landsberg : 1. Aircraft.
2. B.M.W. Allach engine plant.
3. Abandoned.
- Blerichen : Electric steel.
Deutsche Edelstahl.

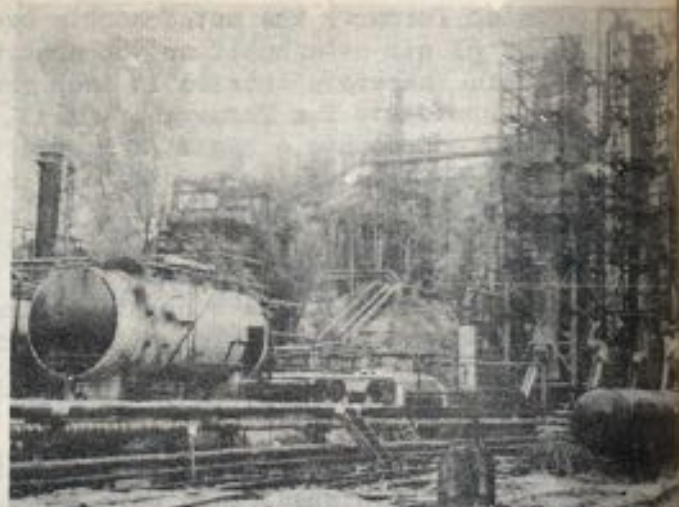

Figure 38 - Denphenolizing Plant at Altenburg - This plant produced diesel oil from excess middle oil from a near-by coal carbonization plant. Absorbers and fractionators at the right and condensers are in the center, concealed by trees.

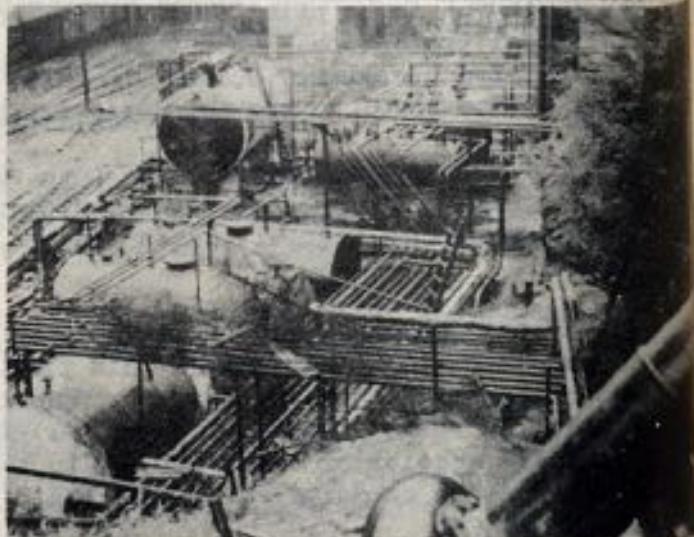

Figure 39 - General view of phenol and diesel oil receivers of the plant above. The railroad in the background supplies coal to the adjacent carbonization plant.



Figure 42 - Concrete Vault at Muehlidorf - Original designed for an eight story airplane factory this shelter was switched to the Buna rubber program. 005



Figure 43 - Concrete Vault at Muehlidorf - The structure is 220 feet wide by 1200 feet long, and the roof is 16 feet thick.

In addition to the methods of protection mentioned above, a number of dummy plants were built and more were considered in an attempt to deceive the attacking air forces. A memorandum dated 27 September, 1944 at Berlin, covering a meeting between General Field Marshall Milch and several plant managers for the exchange of information on the effectiveness of various methods of protecting plants against air raids, contained a statement that these dummy plants drew as high as 30% of the bombs dropped. This statement could not be verified from any other source and seems rather improbable, possibly applying to an isolated case only.

It was found that smoke-screens were most effective when accompanied by jamming of radar. The smoke-screens were made much larger than the plant area and shifted from day to day so that the plant was always in a different location within the screen. A suggestion was made, but apparently never acted upon, that large steel mats be laid within the smoke-screen area in an attempt to cause useless bombing by false indications of the radar equipment.

One fantastic scheme was also suggested to Geilenberg involving the covering of a whole mountain with a thick layer of concrete and then excavating the mountain, leaving the large concrete shell.

CONCLUSIONS

1. The underground and dispersal program as set up in Germany was impractical for the following reasons:

(a) The plants were dispersed too widely and depended on rail transportation almost entirely. This imposed a considerable burden on an already overloaded utility and the railroads were the main bottleneck on the small amount of dispersal plant that was completed.

(b) The program was started much too late to be effective and as a result, the planning was ineffective.

(c) Sources of feed stock, such as carbonization plants and coal hydrogenation plants were still vulnerable to bombing.

(d) Sources of electric power and fuel were still vulnerable to bombing.

2. The program had little effect on the course of the war because it was started too late, and lack of transportation reduced the effectiveness of what little plant capacity was completed.

3. If the program had started one or two years earlier and had been planned more carefully, it is possible that the German oil industry might have been relatively safe from bombing. This would have required the use of more centralized underground plants and a network of pipelines to replace rail transportation. The coal carbonization plants and electric power plants would have required protection also in this case.

4. The underground oil program as a whole cost about 1,400,000,000 RM. and required approximately 200,000 man years of labor. This was a loss of manpower to the German economy indirectly caused by strategic bombing.

5. Operation of an underground oil industry is practical if the following conditions are met:

(a) Plants are centralized near the source of feed.

(b) Feed is handled by pipeline.

(c) A network of product pipelines is established over the country to handle the production.

(d) Hydrogen production equipment is redesigned to minimize leakage.

(e) Adequate ventilation is provided.

(f) Electric power plants and networks are protected.

(g) Coal carbonization and hydrogenation plants are protected.

PART II

PLANT DATA AND DESCRIPTIONS

The following section of this report contains all of the factual data known about the individual underground and dispersal plants. In general, this includes location, parent company identification, status of the work, cost and labor statistics and as far as possible a description of the plant and the processes involved. In most cases, simplified flow diagrams are included.

BASIS OF LABOR CALCULATION

The cost figures obtained from Geilenberg* on the various underground and dispersal plants were based to some extent on files which had not been destroyed and also on estimates from memory on the part of Geilenberg and members of his staff who had been responsible for the cost-accounting on the entire project. These figures are included in the data sheets following.

An average cost figure of 0.90 RM per man hour, plus 100 to 150% for overhead, for all types of labor was also obtained from Geilenberg.

Using this basic data it is possible to obtain an approximate figure for the labor involved in fabricating equipment and machinery and erecting the plant.

Taking a ten hour-day as a basis:

| | |
|--------------------------|----------|
| Cost per man day | = 9 RM. |
| with 125% overhead, etc. | = 20 RM. |

Assume that the cost of the basic raw materials such as coal, iron ore, cement, etc., amounts to 10% of the total cost:

| | |
|-----------------------------------|---|
| Then the total man days of effort | = $\frac{0.9 \times \text{total cost}}{20}$ |
| | = 0.045 x total cost |

This should give an approximation of the total man days of labor involved in fabrication of equipment and machinery, excavation and erection.

*General Commissioner for Immediate Measures under Reichsminister Speer, in charge of the Underground and Dispersal Program.

Gailenberg, who started as a miner and worked up to the position of Manager of the Brunswick Steel Works, was selected by Speer to direct the repair program of the German oil industry. Hitler's order dated 31 May, 1944, reads as follows:

For quickest elimination of air raid damage of vital industries a "General Commissioner for Immediate Measures" is being established attached to the Reichs Ministry for Armament and War Production. The Commissioner enjoys full priority ahead of all others. All existing priority classifications can be voided; functioning of the economic structure, also that of the armament and war production, can be discontinued as the result of his requirements. He can give directives for the execution of the work to the specially organized formations. He is responsible for tackling the work turned over to him with a generous supply of manpower and material and with reckless energy (following is an order to the other agencies concerned.) The speed of the work is not to be impaired either by formal or regional obstacles. Etc.....

GLOSSARY OF GERMAN FIRM NAMES

AND ABBREVIATIONS USED IN THIS REPORT

| | |
|----------------|---|
| A. S. W. | Aktiengesellschaft Saechsische Werke |
| Brabag | Braunkohle-Benzin-Aktiengesellschaft |
| Bruex | Sudetendeutsche Treibstoffwerke Bruex |
| D e a | Deutsche-Erdoel-Aktiengesellschaft |
| Deurag | Gewerkschaft Deutsche-Erdoel-Raffinerie |
| Dt. Gasolin | Deutsche Gasolin Aktiengesellschaft |
| Fanto | Fanto-Werke Prag |
| Gebechem | Commissioner General for the Problems of the Chemical Industry |
| Nerag | Gewerkschaft Neue Erdoel-Raffinerie |
| O T | Organization Todt |
| Speer Ministry | Ministry for Armament and War Production |
| S S | Schutzstaffel (Hitler's Elite Guard) |
| Wifo | Wirtschaftliche Forschungsgesellschaft m.b.h. literally: Economic Research Association Ltd Government agency concerned with storage of gasoline, oil and other primary war materials, also erection of plants for nitric acid, sulphur etc.- |

"SCHWALBE 1"

(Hydrogenation Plant)

(a) General Data:

- | | | |
|------------------------------|---|--|
| 1. Location | : | Oberroedinghausen near Menden/Westphalia. |
| 2. Construction type | : | New underground plant. |
| 3. Company in charge | : | Union Rheinische Braunkohle Benzin A.G. |
| 4. Estimated completion date | : | 15 November, 1945 |
| 5. Design capacity | : | Feed: 15,000 tons per month of coal tar 10,000 tons per month of aviation gasoline 1,200 tons per month of liquified petroleum gas |

(b) Cost and Labor Required:

- | | | |
|---------------------------------------|---|--|
| 1. Estimated total cost | : | 150,000,000 RM. |
| 2. Estimated cost until end of war | : | 85,000,000 RM. |
| 3. Average number of workmen | : | a) Skilled 1,500 b) Unskilled 500 c) Foreign <u>4,000</u> Total 6,000 |
| 4. Construction labor to end of war | : | 1,470,000 man days. |
| 5. Total labor to end of war | : | 3,830,000 man days. |
| 6. Total labor to completion of plant | : | 6,750,000 man days. |

This was to have been an underground hydrogenation plant utilizing coal tar shipped from the Ruhr area. The plant was to operate at 700 atmospheres pressure and was to produce 10,000 tons per month of aviation gasoline. The plant was located in an existing limestone quarry. Twenty-two tunnels, 15 feet square, have been excavated out of the limestone cliff. Where required by equipment, these tunnels were enlarged to 30 feet wide and 70 feet high. The total job involved 360,000 cubic yards of new excavation of which about 200,000 was completed.

The working force of miners consisted of about 1,000 men from September, 1944, until work was stopped. This force, according to the construction manager, should have excavated 2600 cubic yards per day and they actually excavated 2,000 cubic yards per day. Considerable delay was caused by lack of explosives and inefficient labor.

- - - - -

Sources of data:

Mr. Friedrich Ehrhardt, Construction Manager for the Gelsenkirchener Bergwerk A. G.

Dr. Kranepuhl, I. G. Farben, Leuna.

Director Von Felbert, Brabag at Boshlen.

Mr. E. Geilenberg.

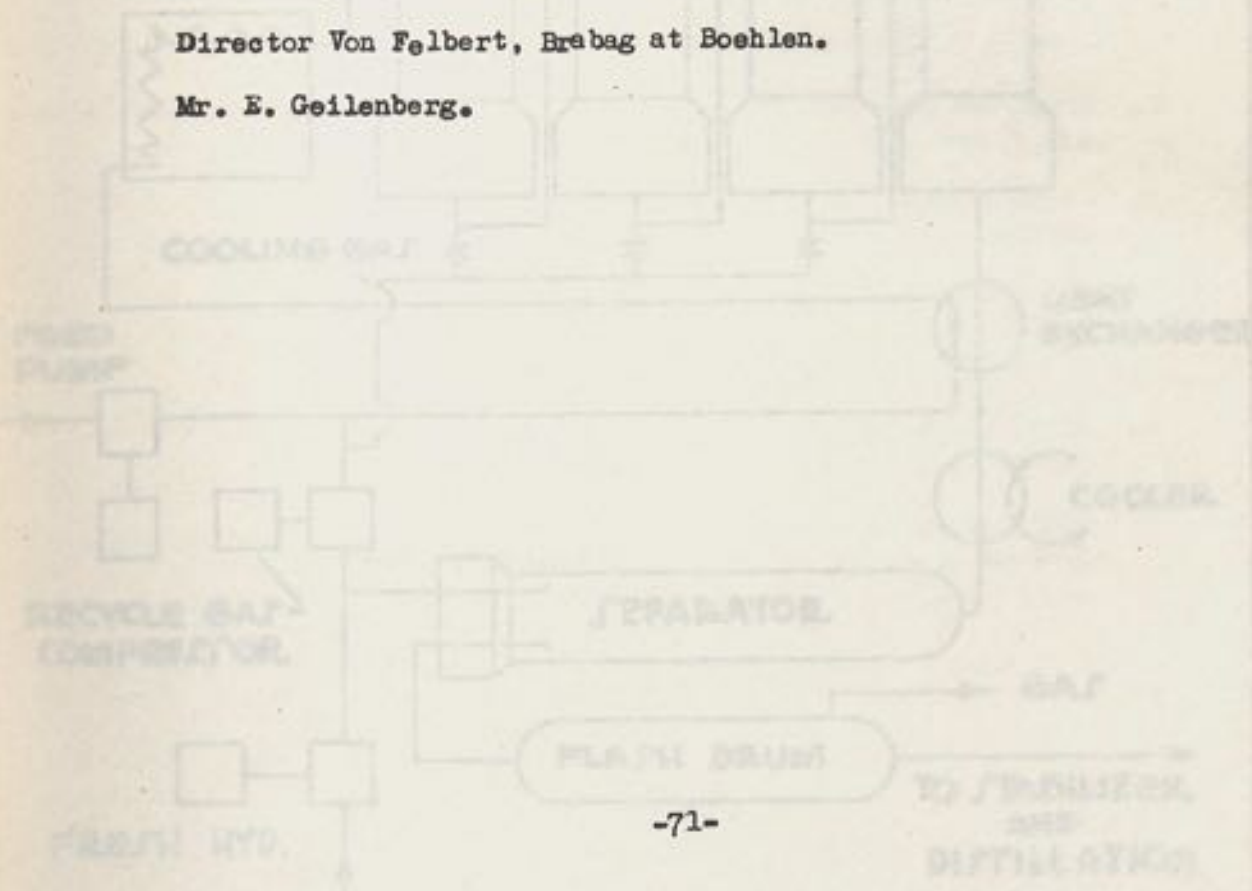

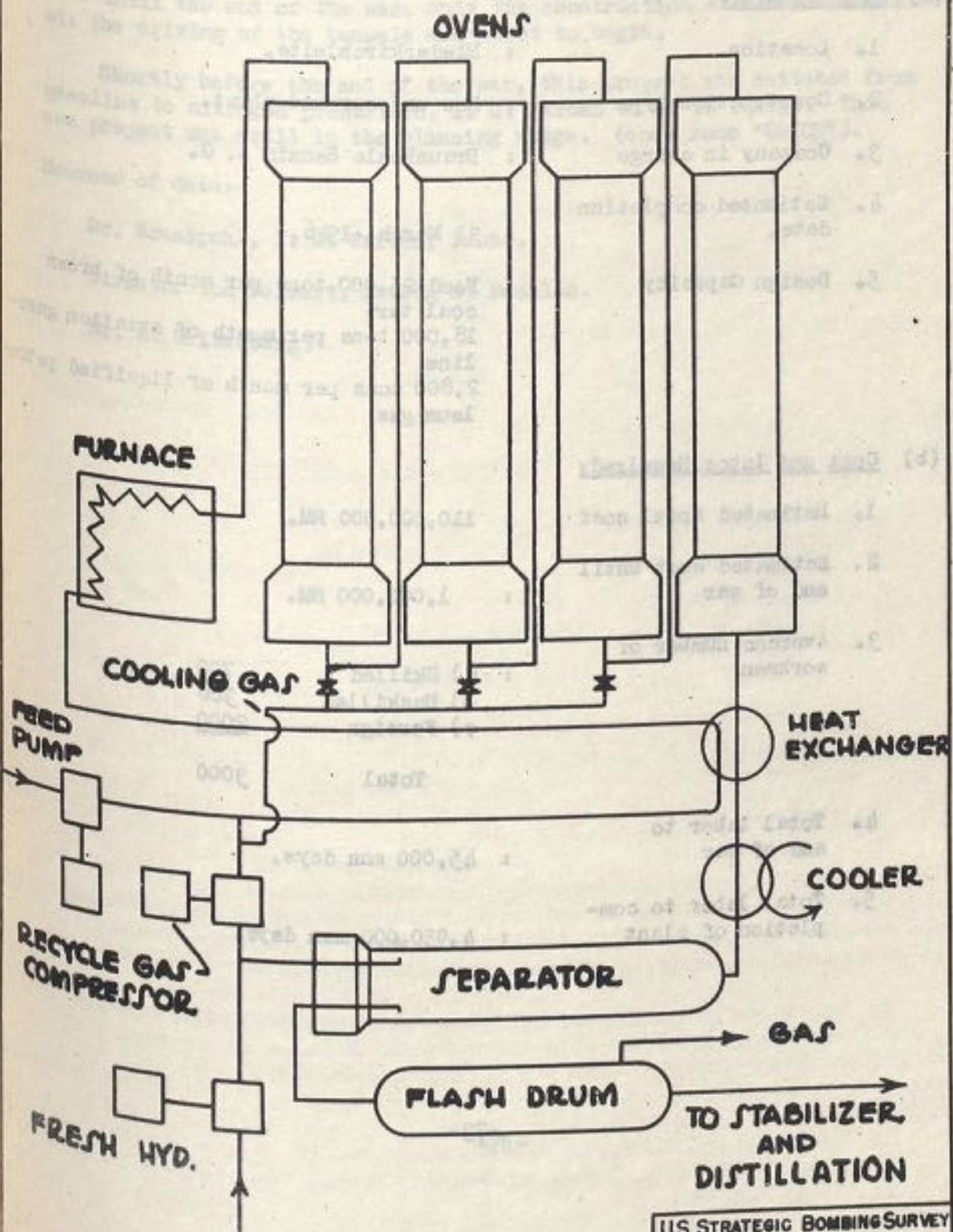

U.S. STRATEGIC BOMBING SURVEY
 HYDROGENATION UNIT
 FIGURE 44

"SCHWALBE 2"

(Hydrogenation Plant)

(a) General Data:

1. Location : Niederkirchleite.
2. Construction type : New underground plant.
3. Company in charge : Braunkohle Benzin A. G.
4. Estimated completion date. : 31 March, 1946.
5. Design Capacity : Feed 25,000 tons per month of brown coal tar
18,000 tons per month of aviation gasoline
2,800 tons per month of liquified petroleum gas

(b) Cost and Labor Required:

1. Estimated total cost : 110,000,000 RM.
2. Estimated cost until end of war : 1,000,000 RM.
3. Average number of workmen :

| | |
|--------------|-------------|
| a) Skilled | 700 |
| b) Unskilled | 300 |
| c) Foreign | <u>2000</u> |
| Total | 3000 |
4. Total labor to end of war : 45,000 man days.
5. Total labor to completion of plant : 4,950,000 man days.

This was to have been an underground hydrogenation plant utilizing brown coal tar obtained from low-temperature carbonization plants in Central Germany. The plant was to operate at 300 atmospheres pressure.

Until the end of the war, only the construction site was established: the driving of the tunnels was about to begin.

Shortly before the end of the war, this project was switched from gasoline to nitrogen production, I. G. Farben to be in charge. This new project was still in the planning stage. (code name "ORION").

Sources of data:

Dr. Kranepuhl, I. G. Farben, Leuna.

Director Von Felbert, Brabag at Boehlen.

Mr. E. Geilenberg.

"SCHWALBE 3"

(Hydrogenation Plant)

(a) General Data:

1. Location : Polenztal.
2. Construction type : New underground plant.
3. Company in charge : Sudetenlaendische Treibstoffwerke.
4. Estimated completion date : Project dropped 31 March, 1945.
5. Design capacity : Feed 15,000 tons per month of coal tar
10,000 tons per month of aviation gasoline.
1,200 tons per month of liquified petroleum gas

(b) Cost and Labor Required:

1. Estimated total cost : 110,000,000 RM.
2. Estimated cost until end of war : 1,000,000 RM.
3. Average number of workmen :

| | |
|--------------|-------------|
| a) Skilled | 300 |
| b) Unskilled | 200 |
| c) Foreign | <u>1000</u> |
| Total | 1500 |
4. Total labor to end of war : 45,000 man days.
5. Total labor to completion of plant : 4,950,000 man days.

This was to have been an underground hydrogenation plant utilizing coal tar obtained from local and Upper Silesian carbonization plants. The plant was to produce 10,000 tons per month of aviation gasoline.

The plant was originally scheduled to be completed in July, 1945, but only the clearing of the site and the establishment of the rail connection had been completed when the project was dropped.

Sources of data:

Dr. Kranepuhl, I. G. Farben, Leuna
Director Von Felbert, Brabag at Boehlen
Mr. E. Geilenberg.

"SCHWALBE A"

(Hydrogenation Plant)

(a) General Data:

1. Location : Heggen.
2. Construction type : New underground plant.
3. Company in charge : Gelsenberg Benzin A. G.
4. Estimated completion date : Construction stopped in April, 1945.
5. Design capacity : Feed 16,500 tons per month of coal tar
10,000 tons per month of aviation gasoline
1,550 tons per month of liquified petroleum gas

(b) Cost and Labor Required:

1. Estimated total cost : 110,000,000 RM.
2. Estimated cost until end of war : 1,500,000 RM.
3. Average number of workmen :

| | |
|--------------|-------------|
| a) Skilled | 300 |
| b) Unskilled | 200 |
| c) Foreign | <u>1000</u> |
| Total | 1500 |
4. Total labor to end of war : 67,500 man days.
5. Total labor to completion of plant : 4,950,000 man days.

This was to have been an underground hydrogenation plant utilizing Brown Coal tar from the Ruhr area.

The construction of the plant had not made much progress when it was stopped. Only the site had been cleared and the digging of the tunnels was about to begin.

Sources of data:

Dr. Kranepuhl, I. G. Farben, Leuna.
Director Von Felbert, Brabag at Boehlen.
Mr. E. Geilenberg.

(Hydrogenation Plant)

(a) General Data:

1. Location : Berga on the Elsterschleife.
2. Construction type : New underground plant.
3. Company in charge : Braunkohle Benzin A. G.
4. Estimated completion date : 1 October, 1945
5. Design capacity : Feed 21,300 tons per month of brown coal tar
15,400 tons per month of aviation gasoline
2,200 tons per month of liquified petroleum gas

(b) Cost and Labor Required:

1. Estimated total cost : 110,000,000 RM.
2. Estimated cost until end of war : 30,000,000 RM.
3. Average number of workmen :

| | |
|--------------|-------------|
| a) Skilled | 700 |
| b) Unskilled | 400 |
| c) Foreign | <u>1400</u> |
| Total | 2500 |
4. Construction labor to end of war : 600,000 man days.
5. Total labor to end of war : 1,350,000 man days.
6. Total labor to completion of plant : 4,950,000 man days.

This was to have been an underground hydrogenation plant utilizing brown coal tar obtained from carbonization plants in Central Germany. The plant was to operate at 300 atmospheres pressure and was to produce 15,400 tons per month of aviation gasoline.

The construction of the tunnels was under the supervision of the Reich and the equipment was to be taken from the Brabag company. Eighteen tunnels on 130 to 170 ft. centers were being driven into the mountainside; these were to be connected at the far end with a railroad tunnel. All 18 tunnels were started simultaneously and when construction was halted by the end of the war, the tunnels had been driven from 180 to 310 feet into the mountain; tunnel cross-sections were about 20 feet high and from 18 to 23 feet wide.

The labor force used for the construction consisted of between 1600 and 2000 political prisoners and slaves, under the guard of 400 to 600 SS troops. In addition to the forced labor, some German skilled labor was used for operating the locomotives, shovels, air compressors, etc. Considering the fact that the work had been in progress for six months (it had begun in November, 1944), and the amount of labor used, the progress was very slow.

- - - - -

Sources of data:

- Dr. Kranepuhl, I. G. Farben, Leuna.
- Director Von Felbert, Brabag at Boshlen.
- Mr. E. Geilenberg.

"SCHWALE: 6"

(Hydrogenation Plant)

(a) General Data:

- | | | |
|------------------------------|---|--|
| 1. Location | : | Tentatively near Linz. |
| 2. Construction type | : | Probably underground plant. |
| 3. Company in charge | : | Hydrierwerk Scholven A. G. |
| 4. Estimated completion date | : | Planning had just begun. |
| 5. Design capacity | : | Feed 15,000 tons per month of coal tar 10,000 tons per month of aviation gasoline. 1,200 tons per month of liquified petroleum gas |

This was to have been an underground hydrogenation plant utilizing coal tar. The plant was to produce 10,000 tons per month of aviation gasoline. There is some indication that a sump phase unit was considered but the whole project was dropped in favor of KLEIN SCHOLVEN.

Sources of data:

Dr. Kranepuhl, I. G. Farben, Leuna.
Director Von Felbert, Brabag at Boehlen.
Mr. E. Geilenberg.

"SCHWALBE 7"

(Hydrogenation Plant)

(a) General Data:

1. Location : Tentatively at Wollin, Baltic Sea.
2. Construction type : In preliminary planning stage only.
3. Raw material charged : Crude oil residuum.
4. Design capacity : Feed 20,000 tons per month of mineral oil
14,000 tons per month of aviation gasoline
1,800 tons per month of liquified petroleum gas

Sources of data:

Dr. Kranepuhl, I. G. Farben.

"SCHWALBE 8"

(Hydrogenation Plant)

(a) General Data:

1. Location : Tentatively at Tetschen.
2. Construction type : In preliminary planning stage only.
3. Raw material charged : 16,000 tons per month of gas oil.
4. Design capacity : Feed 16,000 tons per month of straight-run gas oil
4,500 tons per month of aviation gasoline
1,400 tons per month of motor gasoline
8,800 tons per month of Diesel Fuel

Sources of data:

Dr. Kranepuhl, I. G. Farben.

"KUCKUCK"

(Hydrogenation, Hydroforming, Catalytic Cracking, Alkylation)

(a) General Data

1. Location : Niedersachswerfen near Nordhausen/Harz.
2. Construction type : Underground plant
3. Company in charge : Ammoniakwerk Merseburg, I. G. Farben.
4. Estimated completion date : 1 November, 1945.
5. Design capacity :
 - Feed: 11,000 tons per month of brown coal tar
 - 7,800 tons per month of crude gasoline
 - 6,700 tons per month of straight-run gas oil
 - 1,700 tons per month of alkylate (iso-octane)
 - 8,300 tons per month of hydroformed gasoline
 - 9,400 tons per month hydrogenated aviation gasoline
 - 500 tons per month of liquified petroleum gas

(b) Cost and labor Required

1. Estimated total cost : 150,000,000 RM.
2. Estimated cost until end of war : 70,000,000 RM.
3. Average number of workmen :

| | |
|--------------|--------------|
| a) Skilled | 1,000 |
| b) Unskilled | 500 |
| c) Foreign | <u>3,500</u> |
| Total | 5,000 |
4. Construction labor to end of war : 1,210,000 man days
5. Total labor to end of war : 1,210,000 man days.
6. Total labor to complete plant : 6,150,000 man days.

(c) Excavation Required:

1. Area : 440,000 sq. ft.
2. Volume : 520,000 cu. yds.

This was by far the most complicated of the underground plants. It was to feed brown coal tar, gas oil and crude hydrogenated gasoline from other plants and make aviation gasoline, heating oil and propane. The plant was to consist of the following:

- 2 Hydrogenation units (Gas Phase)
 - Hydroformer
 - Catalytic cracking unit
 - Alkylation and butane dehydrogenation

TUNNELS:

The "Kuckuck" was one of four plants built in the tunnels at Niedersachswerfen. The others were a Junkers aircraft factory, a plant for the manufacture of V-1 and V-2 weapons and a liquid oxygen plant (REER). A plan view of the excavation is shown on Page 83.

The "Ammoniakwerk Merseburg Gipswerk Niedersachswerfen" has been mining the gypsum stone in an open cut since 1918; the stone was crushed to about 2-inch maximum size and shipped to Leuna, where it was used for the production of fertilizer.

In 1936, the Government owned agency concerned with storage of fuels, lube oils, etc. (WIFO), ordered a change from the open cut method to underground mining, the tunnels and chambers produced thereby to be used for storage of fuel and lubricants for the Wehrmacht. The WIFO paid for the difference between the higher mining cost and the open cut method, and for this small sum obtained vast underground storage space. Within 13 months the chambers 1 - 17 were excavated, and 4 months later they were finished up. Each of the chambers is about 20 feet high, 30 feet wide and 550 feet long. These first 16 chambers were later taken by Junkers for an underground aircraft plant. (Feb-Mar, 1944). In September, 1943, the Mittelwerk (production of the V-1 and V-2 weapons) ordered excavation of chambers 18 - 45, these chambers to be of a circular cross-section with a 38-foot diameter and 550 feet long. Mittelwerk was owned by the Reich. This excavation was considerably more expensive due to its rush nature. The gypsum obtained was "dumped" for the time being as it was far in excess of the requirement for fertilizer production.

The B-11 or "Kuckuck" plant was started in April, 1944. It was planned by the Minoel (Mineraloelbau Gesellschaft). The nine chambers were to be 40 feet wide of varying height (mainly 20 feet high), and from 400 to 850 feet long.

The tunnels are at Elevation 700 feet, the high point of the mountain at Elevation 1060 feet, the low point at Elevation 930 feet which means that there was a minimum protective earth cover of about 230 feet. Eight vertical ventilation shafts were planned at various locations. An elaborate ventilation system was designed to keep the temperature down, as the

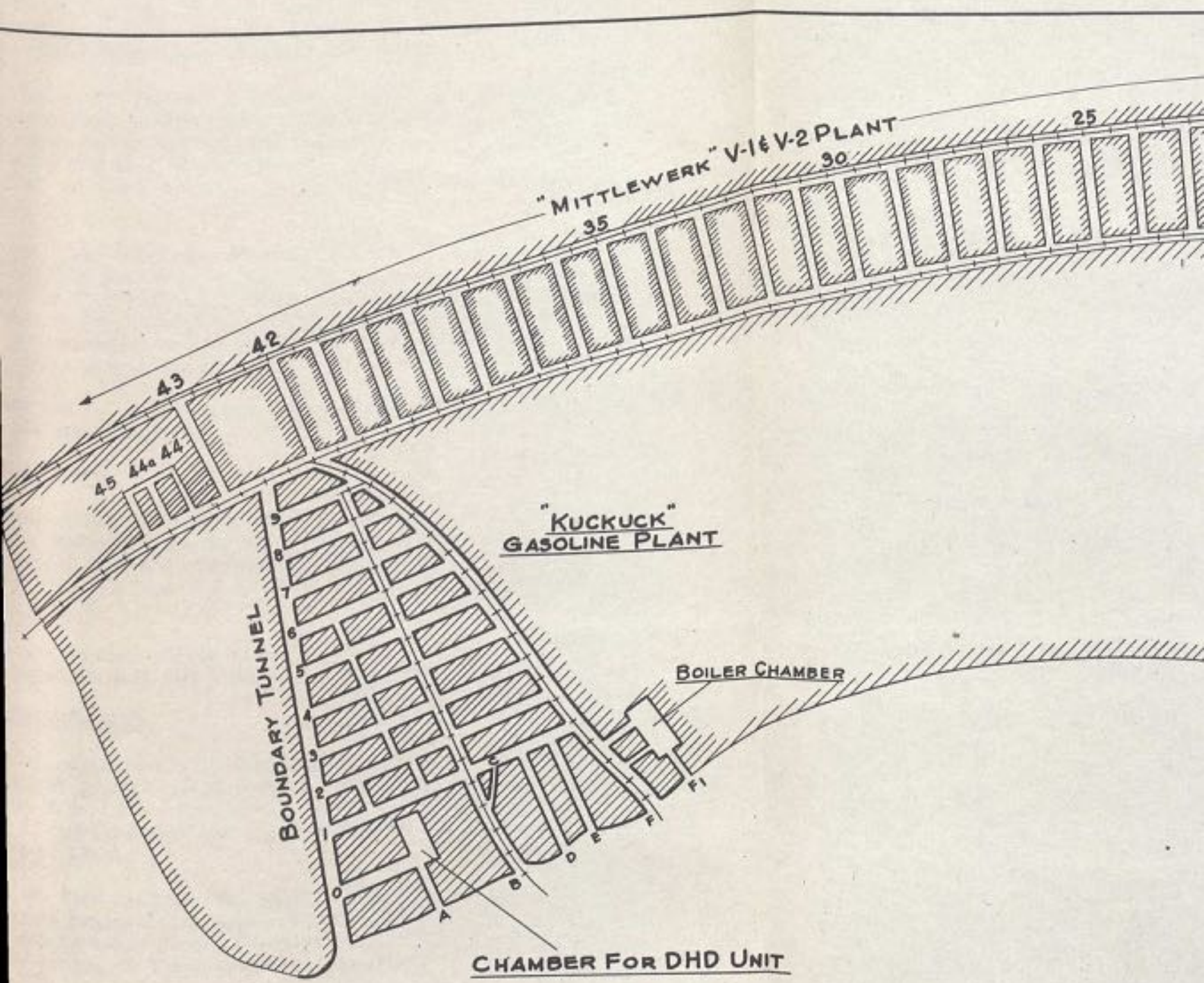

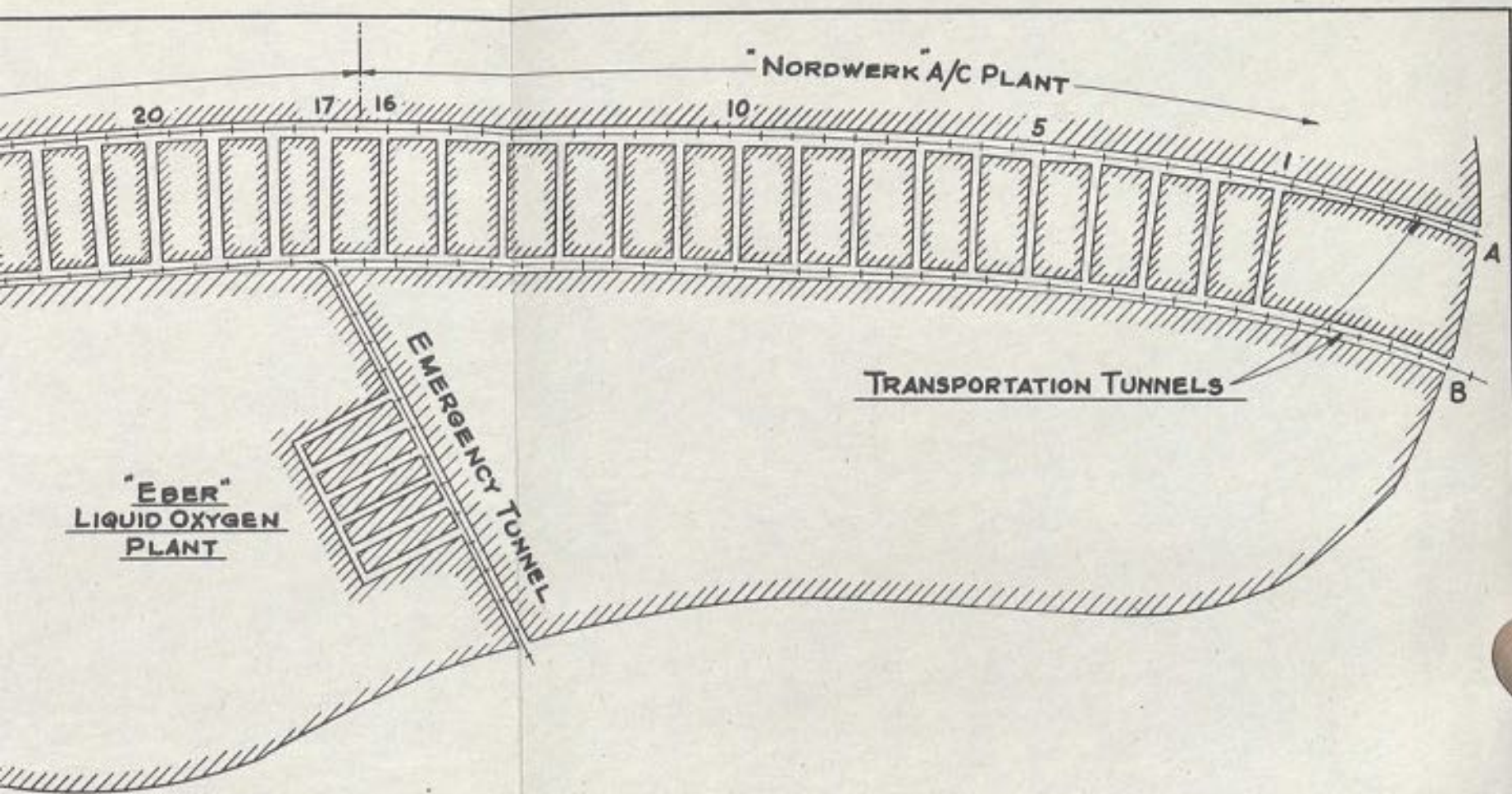

| PLANT | SECTION | DIMENSIONS (FT) | | |
|------------|---|-----------------|------------|--------|
| | | LENGTH | WIDTH | HEIGHT |
| | Transportation Tunnels | 6500-7000 | 50 | 20 |
| KUCKUCK | Boundary Tunnel | 1300 | 33 | 20 |
| | Chambers 1-9 | 400-850 | 40 | 20-30 |
| | Tunnels O, A, B, C, D, E, F, F ₁ | varies | 30 | 20 |
| | Chamber for DHD Unit | 120 | 60 | 92 |
| | Boiler Chamber | U n k n o w n | | |
| EBER | Emergency Tunnel | 860 | 40 | 20 |
| | Chambers | 300 | 30 | 20 |
| NORDWERK | Chambers 1-16 | 550 | 30' | 20 |
| MITTLEWERK | Chambers 17-43 | 550 | 38ft. dia. | |
| | Chambers 44, 44a, 45 | 250 | 38ft. dia. | |

U.S. STRATEGIC BOMBING SURVEY
 UNDERGROUND PLANTS IN
 KOHNBERG AT NIEDERSACHS-
 WERFEN, IN HARZ MTS.
 FIGURE 45

gypsum stone does not withstand high temperature, the stone temperature being normally 50 - 55° F. Each suction-blower of the ventilation system had a capacity of 7,000,000 cu. ft. per hour, resulting in 40 air changes per hour in the D&D section and 10 to 20 changes per hour in other parts of the plant. The ventilators were not very expensive, but the vertical shafts required for this scheme were time and money consuming.

55 - 60% of the excavation was completed. About 2500 men worked on the excavation in addition to 2500 (estimated) prisoners of the SS. The miners worked in three 8-hour shifts, the muckers in two 11-hour shifts. The mountain side was lit at night and blacked out only when planes passed by on the way to their targets. A considerable amount of time was lost in this way.

Production was first scheduled to begin in March, 1945, but work was continuously delayed due to transportation difficulties, tool shortages and difficulties of installation. It would have been quite a job to erect large vessels in the underground chambers with limited headroom prohibiting use of standard erection methods and equipment. Only a few compressors were installed in the tunnels.

All equipment was to be second-hand material from other I. G. Farben plants. (Leuna and Wesseling).

HYDROGENATION UNITS:

The two hydrogenation units were to operate in series, one feeding tar from sump phase hydrogenation of coal elsewhere and feeding its gasoline to the hydroformer and its "middle oil" to the second hydrogenation unit. Middle oil from the second unit was recycled to extinction.

These are conventional hydrogenation units of 4 ovens of 7 cubic meters catalyst capacity each and a normal feed rate of 480 tons per day.

CATALYTIC CRACKING UNIT:

The catalytic cracking unit of Niedersachswerfen was to be a moving bed granular catalyst type of plant somewhat similar to the Thermoform catalytic cracker, except on a smaller scale. I. G. Farben has one semi-commercial unit in operation and the plant in the "Kuckuck" was to be the first commercial plant.

As seen in the flow diagram, the plant consists primarily of a reactor containing a regeneration zone, and a cracking zone, with an inert gas seal between and a bucket type catalyst elevator to move the catalyst from the bottom of the reactor to the top.

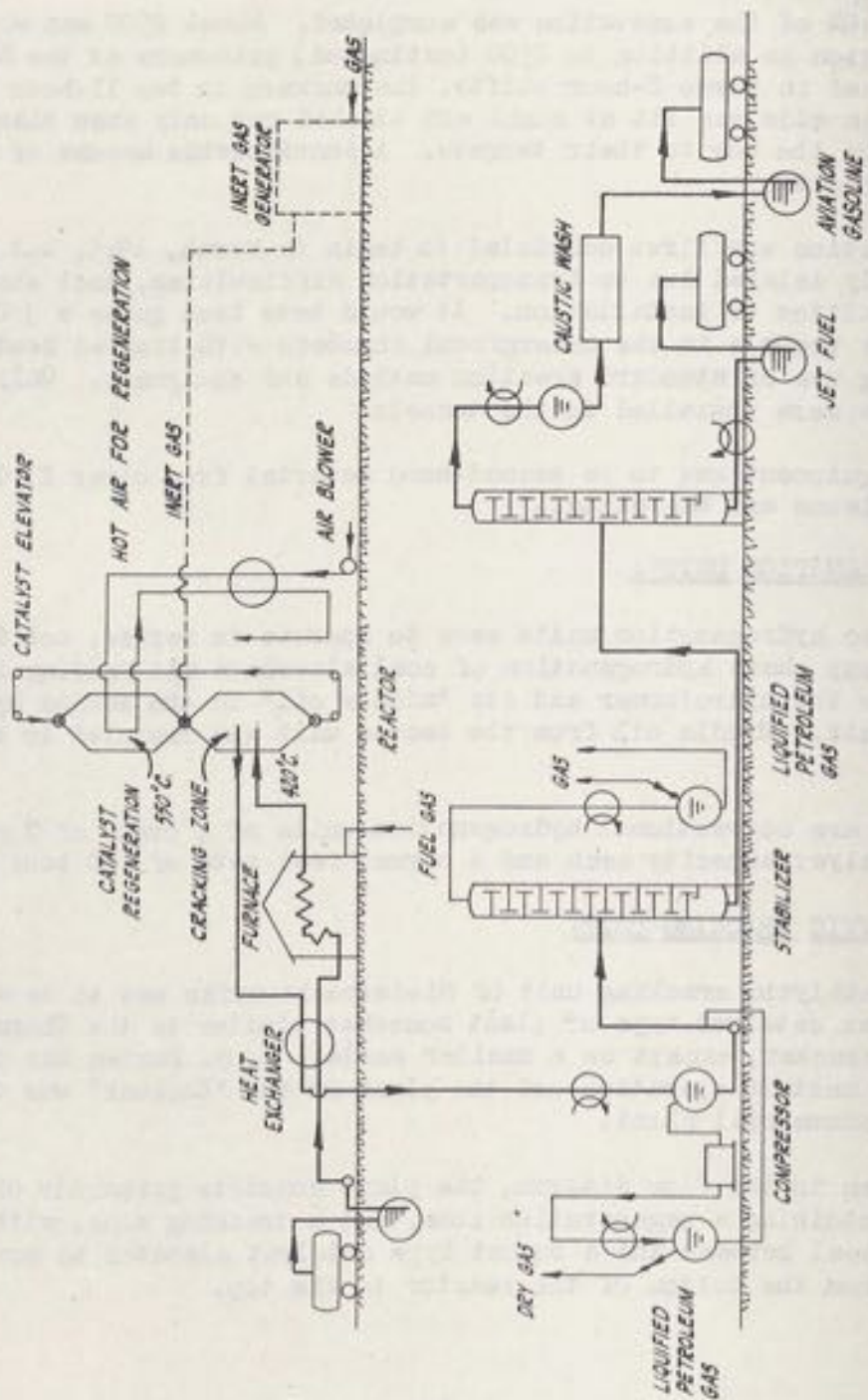

U.S. STRATEGIC BOMBING SURVEY
 CATALYTIC CRACKING UNIT
 FIGURE 46

The catalyst passes first through the regeneration zone where the coke is burned off with hot air. Catalyst temperature is controlled to a maximum of 1020° F. by heat exchange with the incoming air.

The catalyst is cooled to 800° F. in a heat exchanger before passing through the inert gas seal to the cracking zone, where its residence time is one hour.

Vaporized gas oil (390° to 750° F. boiling range) enters the cracking zone at 800° F., is cracked and passes to a condensing, stabilizing and gas recovery system. During the cracking, coke is deposited on the catalyst and some oil is absorbed by the catalyst.

The catalyst then passes through a stripping and cooling zone where it is stripped of oil and cooled by cold hydrocarbon gas before passing through the inert gas seal to the catalyst elevator. The elevator carries the catalyst back to the regeneration zone for removal of coke and the process is repeated.

This plant was designed for a feed rate of 6700 tons/mo. or 240 tons per operating day, and was to yield 4200 tons of catalytically cracked gasoline per month.

Yields in wt. %

| | |
|----------|-------|
| Gasoline | 62.5% |
| Coke | 6.7% |
| Gas | 30.8% |

The heavy products are recycled to extinction by feeding back to the primary gas phase hydrogenation unit from which part of the feed for the cracking unit is drawn.

The gasoline produced is 78 to 79 octane, CFR-MM clear or 90 octane with 0.12% T. E. L.

Content of olefin and aromatics = 25%
Bromine no. = 7 to 8

The catalyst used is 1 part alumina and 9 parts Kieselguhr in 1/4-inch pills.

HYDROFORMING or D. H. D.* UNIT:

The hydroforming process as used in Germany is similar to that used in the U. S. It is a process for dehydrogenation of Naphtenes to aromatics in the presence of hydrogen. The primary difference lies in the fact that the Germans have worked toward long cycles and low coke production and shut down their plants to regenerate catalyst instead of switching reactors.

The plant at Niedersachswerfen was to be similar to an existing plant at Leuna and was to consist of 4 hydroforming reactors in series, with furnaces between for reheating, and one additional catalyst chamber (Raffinator) operating at lower temperature to hydrogenate the olefins produced in the process.

The DHD catalyst used was made by impregnating activated alumina with Molybdic oxide-10 to 12%. The bottom of the Raffinator was loaded with Fuller's Earth and the balance with DHD catalyst.

As shown in the diagram, Page 88, the feed stock is mixed with re-cycle gas containing hydrogen, vaporized and heated by a heat exchanger and furnace No. 1 and is passed over the catalyst in reactor 1 at an inlet temperature of 950° F. Since the reaction requires heat, the vapor leaves the reactor at 840° F. and must be reheated to 970° F. before entering the second reactor. The vapor passes in this manner through all four reactors, is cooled in the heat exchanger and enters the Raffinator at 510° F. Here the olefins formed by the cracking that takes place along with the dehydrogenation are hydrogenated to paraffins.

Typical operating conditions are as follows:

Pressure: Inlet No. 1 Reactor 37 atm. (540 lbs/sq. in)
Outlet Raffinator 29 atm. (425 lbs/sq. in)

| Temperatures: | °F. | |
|---------------|--------------|---------------|
| | <u>Inlet</u> | <u>Outlet</u> |
| Reactor 1 | 946 | 843 |
| 2 | 968 | 889 |
| 3 | 982 | 975 |
| 4 | 968 | 986 |
| Raffinator | 512 | 581 |

These are average temperatures during the "on stream" period. At the beginning of the period, temperatures were somewhat lower and as the catalyst activity declined due to coking of the catalyst, the temperatures were raised.

*Druck H₂ Dehydrierung - literally: pressure Hydrogen Dehydrogenation.

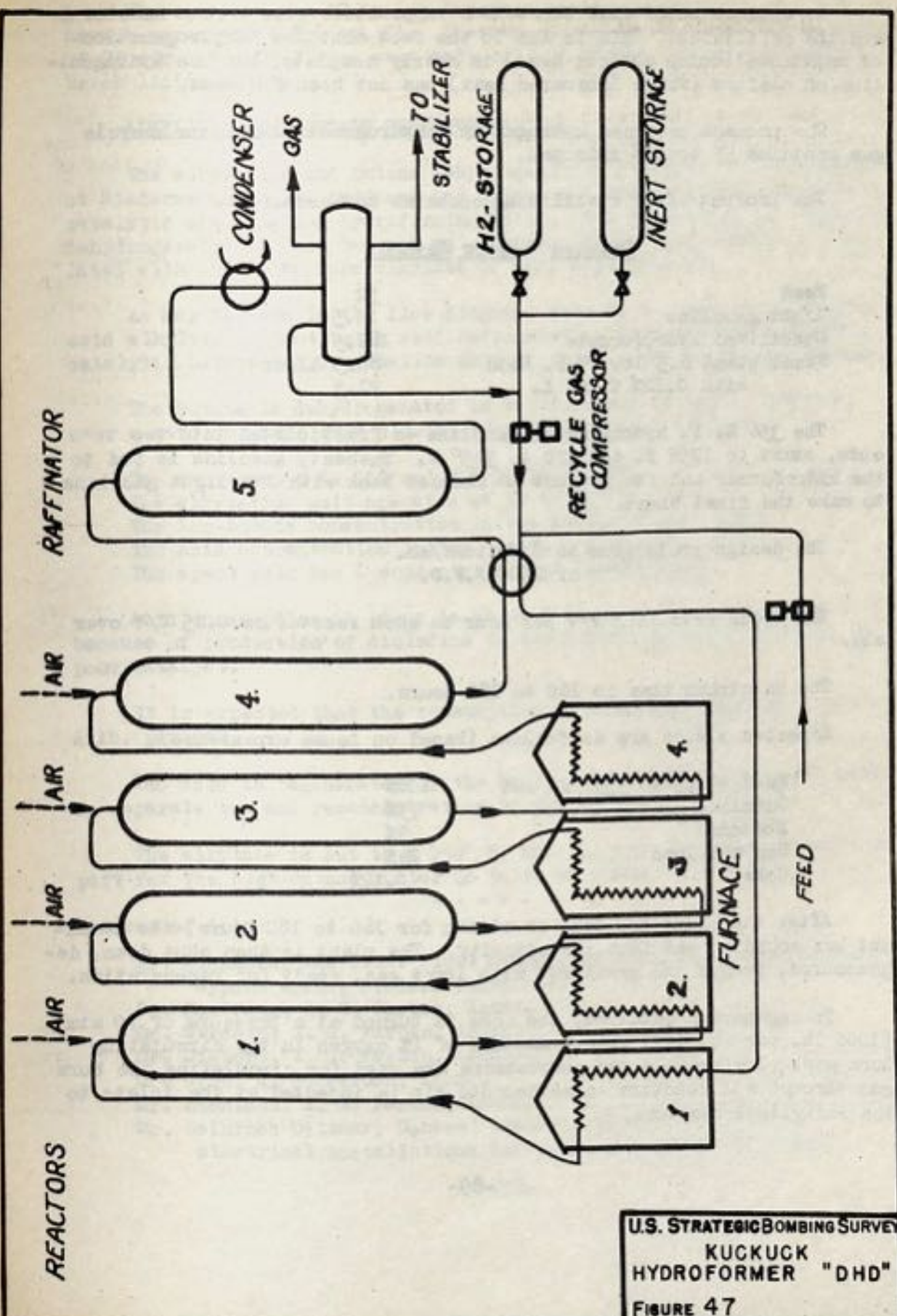

U.S. STRATEGIC BOMBING SURVEY
 KUCKUCK
 HYDROFORMER "DHD"
 FIGURE 47

It will be noted that there is a temperature rise across Reactor 4 and the raffinator. This is due to the fact that the dehydrogenation of naphthenes (which absorbs heat) is nearly complete, but the hydrogenation of olefins (which liberates heat) has not been finished.

The process produces hydrogen by dehydrogenation and the recycle gas contains 55 to 65% hydrogen.

The product after stabilizing contains 66% aromatics.

Octanes - Motor Method:

| | |
|--|--------------------|
| Feed | 52 |
| Light gasoline | 13.5 |
| Stabilized hydroformate | 82.5 |
| Final blend 6.5 lb. V.P. Reid with 0.12% T. E. L. | 80.5 clear 91.5 |

The 35% E. P. hydrogenated gasoline is fractionated into two cuts, start to 175° F. and 170 to 355° F. The heavy gasoline is fed to the hydroformer and the product is blended back with the light gasoline to make the final blend.

The design production is 8300 tons/mo.
or 2500 B.P.D.

The space rate is 1 V/V per hour on each reactor or 0.25 V/V over all.

The on stream time is 160 to 180 hours.

Expected yields are as follows (based on Leuna experience):

| | |
|---------------------------|-------|
| Feed - 175 to 355° F. cut | 100% |
| Gasoline | 73% |
| Bottoms | 3% |
| Gas and loss | 24% |
| Coke | 0.12% |

After the plant has been on stream for 160 to 180 hours, the catalyst has coked up and lost its activity. The plant is then shut down, depressured, purged and pressured with inert gas, ready for regeneration.

To regenerate catalyst, the coke is burned at a pressure of 70 atm. (1000 lb. per sq. in.) with a maximum of 1% oxygen in the circulating burn gas. The recycle gas compressors are used for circulating the burn gas through all reactors in series and air is injected at the inlets to the individual reactors.

The reactors are 52 inches inside diameter by 36 feet long, and have a capacity of 530 cu. ft. They are designed for a working pressure of 70 atm. at 390° F. and were made of 1.5% chrome steel with a fire-brick lining inside.

ALKYLATION AND BUTANE DEHYDROGENATION:

The alkylation and butane dehydrogenation plant at the "Kuckuck" at Niedersachswerfen, obtained its butane cut from the hydrogenation catalytic cracking and hydroforming units. The butane cut is partially dehydrogenated to form butenes and lighter and the iso-butane is alkylated with butene to form alkylate of very high quality.

As may be seen in the flow diagram, this is a conventional sulfuric acid alkylation plant using self refrigeration with the addition of a catalytic butane dehydrogenation unit to produce the necessary butenes.

The butane is dehydrogenated in two furnaces at 1040 - 1080° F. over a catalyst made from alumina plus 8% Cr₂O₃ and 2% K₂O.

The conversion is 16% and the yield is 80%.
The alkylation unit operates at 30 to 35° F.
The iso-butane concentration in the reaction mix = 45%.
The acid concentration in the reaction mix = 50%.
The spent acid has a concentration of 86-88% H₂SO₄.

Acid consumption at Leuna is about 2 lb. per gal. of alkylate because of production of diolefins in the dehydrogenation unit due to poor catalyst.

It is expected that the consumption at Niedersachswerfen will be 1 lb. per gal,

The acid is regenerated by the hauling process-dilution with water to separate tar and reconcentrating to 96% H₂SO₄.

The alkylate is cut to a 250° F. EF, and this accounts at least in part for the high-octane number of 96 to 98 OZMM.

Sources of data:

Mr. Eichhorn, Assistant Plant Manager of Ammoniakwerk Merseburg,
Gypsum Works, Niedersachswerfen.
Dr. Kauffman, I. G. Farben, Leuna.
Dr. Straetz, I. G. Farben, Leuna.
Dr. Dieters, I. G. Farben, Leuna.
Dr. Cron, I. G. Farben, Leuna.
Mr. Haenisch, I. G. Farben, Leuna.
Mr. Heinrich Dittmar, General Electric (AEG), in charge of
electrical installations for all four underground plants.

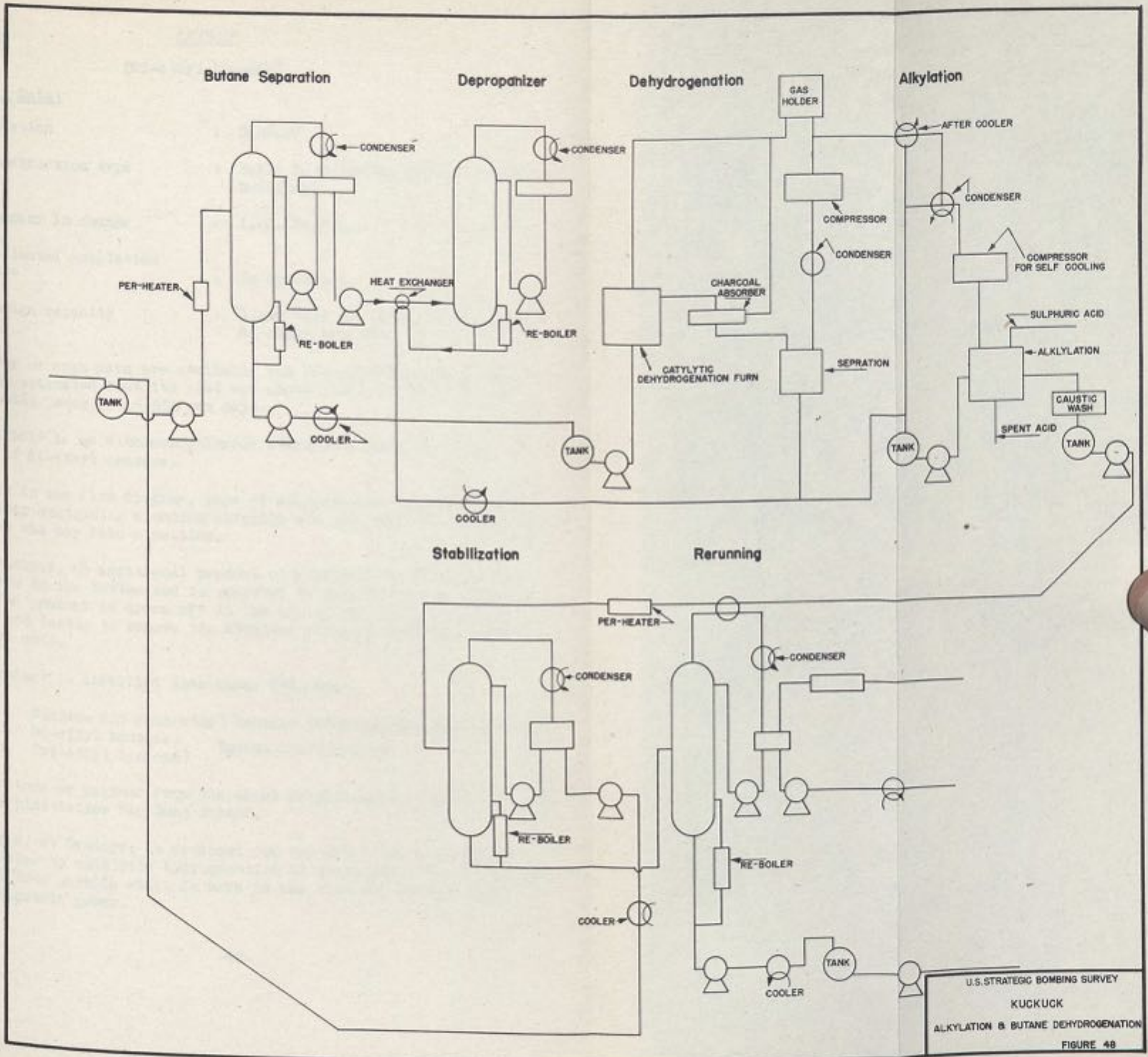

U.S. STRATEGIC BOMBING SURVEY
 KUCKUCK
 ALKYLATION & BUTANE DEHYDROGENATION
 FIGURE 4B

"KYBOL"

(Di-ethyl-benzene)

(a) General Data:

- | | |
|------------------------------|--|
| 1. Location | : Gendorf |
| 2. Construction type | : Built in existing chemical plant building. |
| 3. Company in charge | : I. G. Farben. |
| 4. Estimated completion date | : In operation. |
| 5. Design capacity | : 1,400 tons per month of finished di-ethyl benzene. |

No labor or cost data are available but from observation of the plant, it is estimated that its cost was about 1,000,000 RM, with an estimated total labor of 45,000 man days.

The "Kybol" is an aluminum chloride alkylation plant for the production of di-ethyl benzene.

As seen in the flow diagram, page 93 ethylene and benzene are fed into a reactor containing aluminum chloride and the reaction mixture is drawn off at the top into a settler.

The catalyst, an additional product of aluminum chloride and benzene, settles to the bottom and is recycled by gravity to the reaction chamber. The product is drawn off at the top of the settler, washed with water and caustic to remove the aluminum chloride and fed to the distillation unit.

The product is distilled into three (3) cuts:

1. Benzene and mono-ethyl benzene (atmospheric distillation).
2. Di-ethyl benzene) Vacuum distillation.
3. Tri-ethyl benzene)

The bottoms or polymer from the third distillation is useful to some extent as a plasticizer for Buna rubber.

Ethylene, at Gendorf, is produced for the Kybol and a number of other processes by catalytic hydrogenation of acetylene. The acetylene is produced from carbide which is made in the vicinity using a local excess of electric power.

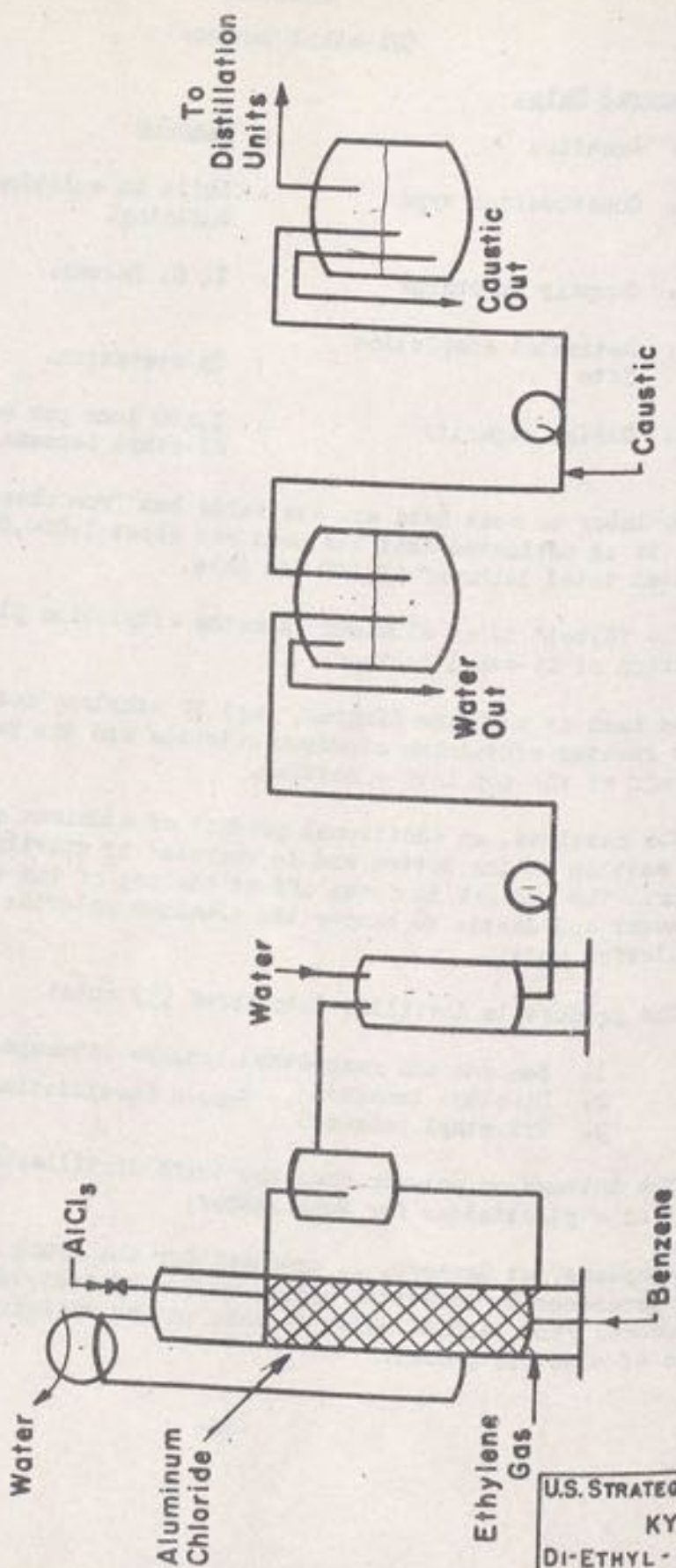

U.S. STRATEGIC BOMBING SURVEY
 KYBOL
 DI-ETHYL - BENZENE PLANT
 FIGURE 49

The plant will produce 1400 tons per month of di-ethyl-benzene or 1000 tons per month di-ethyl-benzene and 500 tons per month of mono-ethyl-benzene.

YIELDS: 80 - 85% Di-ethyl-benzene.
10 - 15% Tri-ethyl-benzene.
5 - 10% Polymer.

The "Kybol" plant was built in two parallel units inside of a reinforced concrete building which had previously housed other chemical equipment. This building was one of twenty or more buildings partly hidden in the woods and comprising the I. G. Farben chemical plant at Gendorf.

- - - - -

Sources of data:

Dr. Ambrose, I. G. Farben, Member of the Board in charge of
organic chemicals.
Dr. Alt, I. G. Farben.

"FASAN 1 - 2"

(Benzene Alkylation Plant)

These plants were to alkylate benzene and the mixed olefines from cracking still gases. The process and equipment are similar to the KYBOL plant.

FASAN 1: Location - Auschwitz.

FASAN 2: Location - Deggendorf.

- (a) Estimated completion date: 1 September, 1945.
- (b) Planned capacity: 1000 tons per month of mixed alkyl benzenes.

FASAN 2 was to be built at the site of the Taube 1 plant at Deggendorf and was to operate on the gases from that plant. Production of mixed ethyl-benzenes for use in aviation gasoline was to be 750 tons per month.

- - - - -

Sources of data:

Mr. Fischer, Asst. Chief Engineer, Deggendorf Refinery,
Sueddeutsche Bau G.m.b.H.

ILTI 1

(Super Fractionation)

(a) General Data:

1. Location : Ebensee on Traunsee/Upper Danube.
2. Construction type : Open construction above ground
3. Company in charge : Ruhr Chemie.
4. Estimated completion date : 1 June, 1945.
5. Design capacity : Feed: 2,000 tons per month of gasoline
1,000 tons per month of aviation gasoline
200 tons per month of Heptane
750 tons per month of motor gasoline

(b) Cost and Labor Required:

1. Estimated total cost : 800,000 RM.
2. Estimated cost up to end of war : 400,000 RM.
3. Average number of workmen :

| | |
|--------------|-----------|
| a) Skilled | 30 |
| b) Unskilled | 30 |
| c) Foreign | <u>70</u> |
| Total | 130 |
4. Construction labor to end of war : 12,000 man days.
5. Total labor to end of war : 18,000 man days.
6. Total labor to completion of plant : 36,000 man days.

Sources of data:

Mr. Kurt Schneider, Planungsamt, Speer Ministry
Mr. E. Geilenberg

"ILTIS 2"

(Super Fractionation)

(a) General Data:

1. Location : Laube on the Elbe, north of Tetschen
2. Construction type : Open construction above ground.
3. Company in charge : Ruhr Chemie.
4. Design capacity : Feed: 2,000 tons per month of gaso-
line
1,000 tons per month of aviation gas
line
200 tons per month of Hep tane
750 tons per month of motor gasoline

This project was stopped during planning.

"ILTIS 3"

(Super Fractionation)

(a) General Data:

1. Location : Almetal near Brilon/Westphalia.
2. Construction type : Open construction above ground.
3. Company in charge : Ruhr Chemie.

This project was stopped during planning.

- - - - -

Sources of data:

Mr. Kurt Schneider, Planungsamt, Speer Ministry.
Mr. E. Geilen berg.

"KRANICH"

(Catalytic Cracking Plant)

(a) General Data:

1. Location : Laube on the Elbe, near Tetschen.
2. Company in charge : Ruhr Chemie.
3. Estimated completion date : 1 April, 1945.
4. Design capacity : Feed: 16,000 tons per month of Diesel Oil
4,300 tons per month of aviation gasoline
1,430 tons per month of motor gasoline
8,800 tons per month of Diesel Oil

This plant was designed for the catalytic cracking of gas-oil, but never was carried beyond the planning stage. It was to feed straight gas-oil to produce aviation and motor gasoline.

Feed Rate 16,000 Tons per Month.

Aviation Gasoline Production : 4300 tons per mo.
Motor Gasoline Production : 1430 tons per mo.
Diesel Oil Production : 8800 tons per mo.

Sources of data:

Dr. Kranepuhl, I. G. Farben, Leuna.

Files of Prof. Krauch, Commissioner General for Problems of the Chemical Industry.

"KLEIN SCHOLVEN 1-3"

(Hydrogenation Plants)

I. GENERAL: After the bombing of the hydrogenation plant at Scholven, it was planned to build three small plants from salvaged equipment. The small units, Klein Scholven, were to be built in concealed positions near the original Scholven plant.

II. KLEIN SCHOLVEN 1:

- | | |
|------------------------------|---|
| 1. Location | : Dispersed in pine woods near Dorsten. |
| 2. Company in charge | : Scholven Hydrierwerke. |
| 3. Estimated completion date | : June, 1945. |
| 4. Design capacity | : Feed: 4500 tons per month of middle oil. 3400 tons per month of aviation gasoline. |

This plant was a gas phase unit and was to utilize feed obtained from Klein Scholven.2. Transportation of feed and products was to be by motor tank trucks. Hydrogen for the plant was to be piped from Huels using an 8" line. It was intended to heat the feed by electric resistance heaters rather than by the conventional fired preheater furnace. The clearing of the site began in November, 1944, and actual construction began about 1 January, 1945.

III. KLEIN SCHOLVEN 2:

- | | |
|------------------------------|---|
| 1. Location | : Abandoned buildings of old coal mine near Recklinghausen. |
| 2. Company in charge | : Scholven Hydrierwerke. |
| 3. Estimated completion date | : 31 May, 1945 |
| 4. Estimated total cost | : 800,000 RM. |
| 5. Design capacity | : Feed: 6250 tons/mo. of carbonization tar. 4500 tons/mo. of middle oil. |

This plant was to operate in sump phase only. The middle oil produced was to be fed to Klein Scholven 1.

The mine at which the plant was located had been idle for five years so its buildings would have served as good camouflage.

The progress of the war prevented the construction of the plant going much beyond the building of the foundations, even though much of the equipment was already at the site.

IV. KLEIN SCHOLVEN 3:

1. Estimated completion date : 30 June, 1945.
2. Estimated total cost : 1,000,000 RM.
3. Design capacity : Feed: 6250 tons/mo. of carbonization tar.
4000 tons/mo. of aviation gasoline.
600 tons/mo. of liquified petroleum gas.

This plant consisted of both gas phase and sump phase units.

Sources of data:

Trip report - Mr. M. Garrity, U. S. Strategic Bombing Survey, Team 35

Files of Prof. Krauch, Commissioner General for Problems of the Chemical Industry.

"OFEN 1 - 40"

(a) General Data:

1. Location : See table following.
2. Construction type : Ofens 23/30 constructed underground; all others above ground.
3. Company in charge : See table following.
4. Estimated completion date : 36 units completed
5. Design capacity : Feed: 3,000 tons per month each OFEN
300 tons per month motor gasoline
1,200 tons per month Diesel Oil

(b) Cost and Labor Required

1. Estimated total cost : 30,000,000 RM
2. Estimated cost until end of war : 30,000,000 RM
3. Average number of workmen :

| | |
|--------------|--------------------|
| a) Skilled | 1,600 / 80-90 days |
| b) Unskilled | 1,600 |
| c) Foreign | <u>4,000</u> |
| Total | 7,200 |
4. Construction labor : 640,000 man days.
5. Total labor : 1,350,000 man days.

The "OFENS" were small continuous distillation units removing gasoline overhead and taking one side cut of kerosene or Diesel Oil. The units were built in pairs above the ground, each consisting of a furnace, heat exchange, a 16-plate column, 31 inches in diameter, and the necessary pumps and condensers. Two or three captured Russian locomotives were provided for each pair of "OFENS" to furnish steam for distillation. Originally, the program called for the construction of 40 small units of 1250 tons per month each. This was changed to 20 units of 3000 tons per month each and later increased to 40 units built in pairs.

The crude is desalted before distilling and treatment of the gasoline consists of a simple caustic wash. The gasoline produced is of relatively low octane number and is used only for motor fuel.

| OPEN | LOCATION | COMPANY | COMPLETION DATE | TO SERVE |
|----------------------------------|---|---|--|--------------------------------|
| 1-2 | Boegerhof | Nerag | September 18, 1944 | Dachs 1 |
| 3-4 | Brunkensen | Nerag | September 20, 1944 | Dachs 1 |
| 5-6 7-8 | Messinghausen Muehlenbein | Wintershall-A.G. Wintershall-A.G. | September 21, 1944 September 30, 1944 | Taube 2 Taube 2 |
| 9-10 | Muehlental | Deutsche Erdoel-A.G. | September 23, 1944 | |
| 11-12 13-14 15-16 | Tuernitz Weitenegg Spitz | I.G. Farben-Industrie, Moosbierbaum I.G. Farben-Industrie, Moosbierbaum I.G. Farben-Industrie, Moosbierbaum | September 15, 1944 September 30, 1944 September 15, 1944 | Dachs 6. Dachs 6 Dachs 6 |
| 17-18 | Petzenkirchen | Ostmaerkische Mineraloelwerke, Lobau | September 15, 1944 | Taube 1 |
| 19-20 21-22 | Alte Post I Alte Poste II | Deutsche Gasolin AG Deutsche Gasolin AG | September 22, 1944 September 25, 1944 | Dachs 7 Dachs 7 |
| 23-30 | Ebensee | Deutsche Erdoel A. G. | August 10, 1944 | Dachs 2 Taube 1 |
| 31-32 | Statzendorf | Shell -Floridsdorfer | October 30, 1944 | Taube 1 |
| 33-34 35-36 37-38 39-40 | Hauskirchen Nob built Bockethal Deutsch-Brod | S. S. Nerag Fanto or S. S. | September 30, 1944 November 3, 1944 | Taube 1 Dachs 1 Dachs 3 |

Tankage usually consisted of the following:

Two 3,000-barrel crude tanks built of concrete.

Two 3,000-barrel residuum tanks, also of concrete.

Four 500-barrel steel tanks for gasoline and Diesel oil.

These plants were usually located in hilly and wooded country close to a railroad and a stream or river, in order to provide water supply.

All crude was shipped in and all products were shipped out by railroad. The residuum was shipped to the TAUBE (cracking plants) or to the DACHS (lube oil plants).

These plants produced 10 to 15% gasoline and 30 to 40% Diesel oil, or if desired, they could make kerosene instead of Diesel oil at a lower yield.

The capacity of the double "OFEN" was 2x120 = 240 Tons per day or 6000 T/M. based on a 25 day month.

Since a unit of this sort usually shuts down for repairs only about once in six months (95% operating factor) the actual capacity available would be 6850 T/M.

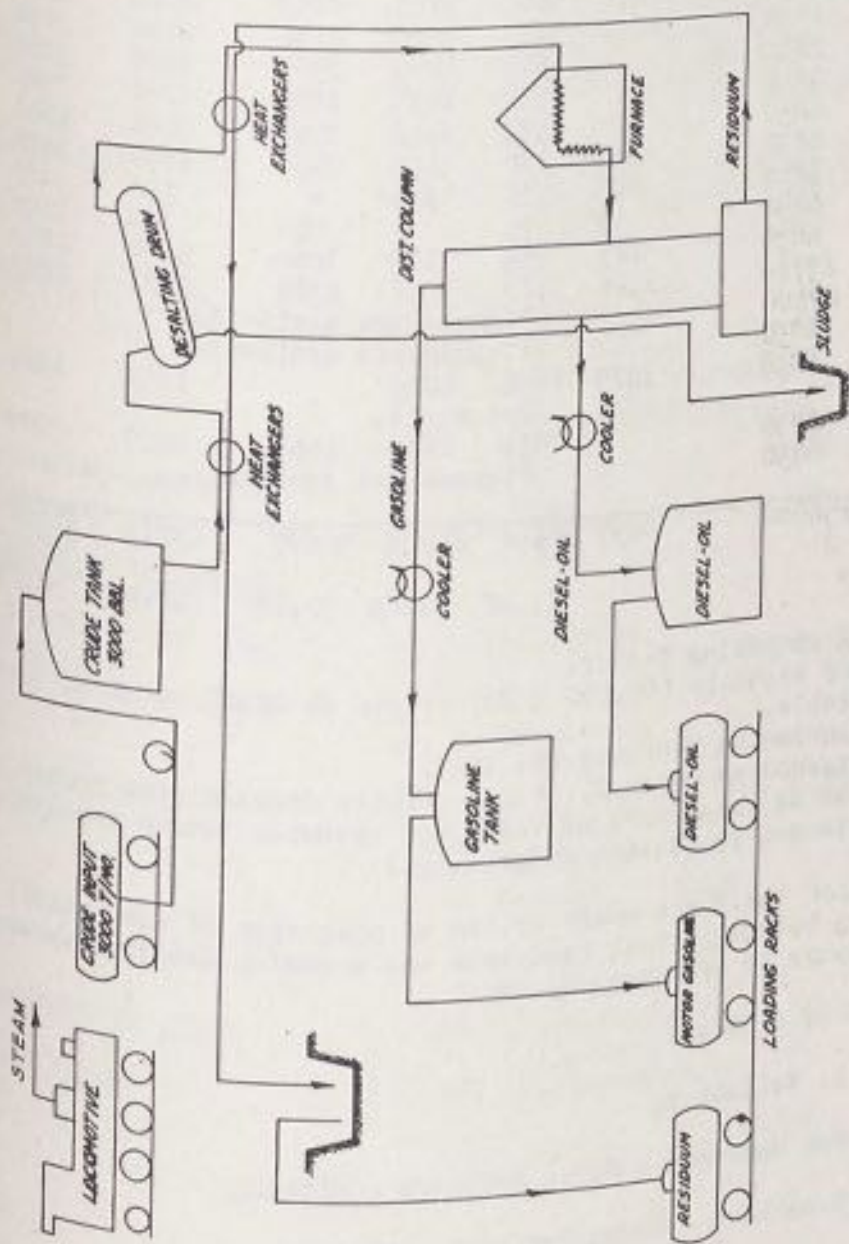

U.S. STRATEGIC BOMBING SURVEY
 "OFEN"
 SMALL TOPPING UNIT
 FIGURE 50

CRUDE RUNS ON "OFENS" (TONS PER MO.)

DISPERSED TOPPING PLANTS

| <u>OFEN</u> | <u>CAPACITY</u> ¹ | <u>DISPERSED TOPPING PLANTS</u> | | | | | |
|-------------|------------------------------|---------------------------------|--------------|--------------|--------------|-------------------------|-------------------------|
| | | <u>Oct</u> | <u>Nov</u> | <u>Dec</u> | <u>Jan</u> | <u>Feb</u> ³ | <u>Mar</u> ⁴ |
| 1-2 | 6850 | 2478 | 5161 | 5761 | 6013 | 2700 | 5000 |
| 3-4 | 6850 | 2478 | 3243 | 3360 | 4732 | 2700 | 3000 |
| 5-6 | 6850 | | 1322 | 2483 | 2360 | 1200 | 3000 |
| 7-8 | 6850 | | 1539 | 1931 | 1992 | 1200 | 3000 |
| 9-10 | 6850 | | 2498 | 3912 | 3340 | 3400 | 4000 |
| 11-12 | 6850 | 339 | 790 | 2163 | 2528 | 1900 | 3000 |
| 13-14 | 6850 | 203 | 375 | 545 | - | 150 | 3000 |
| 15-16 | 6850 | 9 | 94 | 2 | 840 | 150 | 3000 |
| 17-18 | 6850 | 777 | 994 | 180 | 1660 | 3400 | 4000 |
| 19-22 | 13700 | 2324 | 3413 | 3247 | 4569 | 4175 | 6000 |
| 23-30 | 27400 | Figures not available. | | | | | |
| 31-32 | 6850 | Figures not available. | | | | | |
| 33-34 | 6850 | 1379 | 2228 | 4025 | | 1700 | 4500 |
| 35-36 | | Not built. | | | | | |
| 37-38 | 6850 | | 819 | 1630 | 4963 | 2400 | 5000 |
| 39-40 | 6850 | Figures not available. | | | | | |
| | <u>136800</u> | <u>9937</u> | <u>22416</u> | <u>29239</u> | <u>32997</u> | <u>25075</u> | <u>46500</u> |
| | ² | | | | | | |
| % Capacity | | 25.2% | 32.8% | 37.1% | | 28.2% | 52.2% |

1 At 95% operating factor.

2 In % of capacity (89,000 T/Mo) of the 26 OFENS on which data is available.

3. As planned on February 20, 1945.

4 As planned on March 21, 1945. (These figures were probably not reached as shortages of crude and transportation usually reduced the planned production materially.)

Except for the first month or two of operation of each plant, the difference between actual feed rate and capacity usually represents lack of crude or transportation.

Sources of data:

Mr. E. Geilenberg

Mr. Von Heereman - Nerag Refinery - Misburg

Mr. Brockhaus - Nerag Refinery - Misburg

"ROST 1 - 5"

(Primitive Crude Distillation)

(a) General data

1. Location : Rost 1 - Hannover-Linden
2 - Salzwedel near Hanover.
3 - Anderten near Hanover.
4 - Zeche Amalia-Harpen Dortmund.
5 - Oberhausen-Holten
2. Construction type : a) Partly existing buildings.
b) Partly open construction above ground.
3. Company in charge : Rost 1 - Nerag.
2 - DDA.
3 - Nerag.
4 - Harpener Bergbau.
5 - Ruhr Chemie.
4. Estimated completion date : Finished

(b) Cost and Labor Required:

1. Estimated total cost : 4,200,000 RM.
2. Estimated cost up to end of war : 4,200,000 RM.
3. Average number of workmen : a) Skilled 250
b) Unskilled 500
c) Foreign None
Total 750
4. Construction labor : 67,00 man days.
5. Total labor : 189,000 man days.

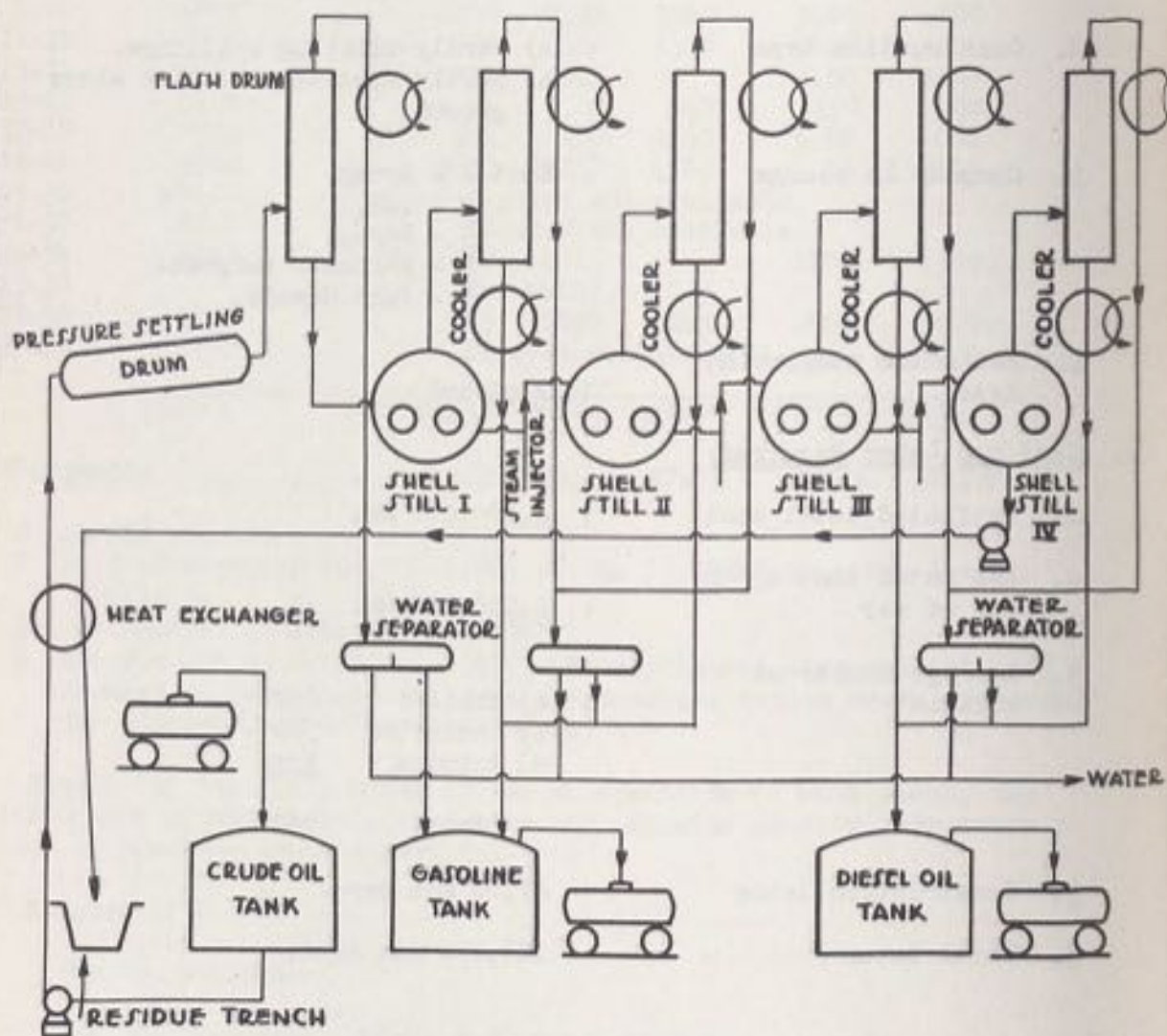

U.S. STRATEGIC BOMBING SURVEY
 "ROST"
 FLOW DIAGRAM
 FIGURE 51

"ROSTS"

The "ROSTS" were primitive distillation units built from salvaged equipment and usually located in ruined plants for camouflage purposes. The equipment was salvaged from bombed out plants and put together as the situation demanded in order to get some production going again. In some cases, locomotive type boilers were used with a fractionating column welded to the top of the boiler.

There were five of these plants and together they represented an appreciable crude running capacity, but this capacity was never fully utilized because of the shortage of crude.

PRIMITIVE CRUDE DISTILLATION UNITS

CRUDE OIL THROUGHPUT TONS PER MONTH

| | <u>Crude Capacity</u> | <u>Sept</u> | <u>Oct</u> | <u>Nov</u> | <u>Dec</u> | <u>Jan</u> | <u>Feb</u> | <u>Mar</u> |
|------------------|-----------------------|-------------|------------|------------------------|------------|------------|------------|------------|
| Rost 1 | 9000 | 875 | 4867 | * | * | 273 | 4000 | 2700 |
| 2 | 9000 | | 212 | 479 | 224 | | | |
| 3 | 9000 | | | | 1153 | 2781 | 3000 | 2700 |
| 4 | 8000 | | | Figures not available. | | | | |
| 5 | 35000 | | | Figures not available. | | | | |
| | 70000 | 875 | 5079 | 479 | 1377 | 3054 | 7000 | 5400 |
| % Capacity Used: | | ** | 18.8 | 1.9 | 5.1 | 11.3 | 24.9 | 20.0 |

Yields: 10-15% Gasoline
30-40% Diesel or Gas Oil

* Shut down probably because of crude shortage.

** On 3 plants for which data is available-27000 T/Mo. crude capacity.

- - - - -

Sources of data:

Dr. Brockhuas, of the Nerag Refinery, Misburg
Mr. E. Geilenberg.

"TAUBE 1"

(Cracking Plant)

(a) General Data:

1. Location : Deggendorf/Danube/Lower Bavaria.
2. Construction type : Above ground along the face of a cliff.
3. Company in charge : Continent Oil A. G.
4. Estimated completion date : 30 May, 1945
5. Design capacity : Feed: 14,100 tons per month residuum from OFENS
Prod: 3,500 tons per month of gasoline
700 tons per month of liquified petroleum gas
2,100 tons per month of Diesel fuel
6,200 tons per month of Fuel Oil

(b) Cost and Labor Required:

1. Estimated total cost : 14,000,000 RM.
2. Estimated cost until end of war : 12,000,000 RM.
3. Average number of workmen : a) Skilled 550
b) Unskilled 900
c) Foreign 400
Total 1850
4. Construction labor to end of war : 194,000 man days.
5. Total labor to end of war : 540,000 man days.
6. Total labor to completion of plant : 630,000 man days.

This plant is a combination distillation, cracking and benzene alkylation plant, located on the Danube River near Deggendorf.

The plant is strung out along the side of a cliff and is partially camouflaged. The plant consists of the following units:

1. A distillation unit with a crude capacity of 50,000 tons per month.
2. A cracking plant with a reaction chamber operating at 70 atmospheres.
3. A doctor treating plant.
4. A stabilizer.
5. A second distillation unit with a capacity of 25,000 tons per month.
6. A "KYBOL" or benzene alkylation unit producing 1,000 tons per month of mixed ethylene benzenes from benzol and cracking plant gases.

Most of the feed stock is brought in by barge on the Danube. Railway transportation is also available. From the transportation standpoint this was by far the most practical of the dispersal plants.

It was planned to bring in Austrian, Hungarian and Rumanian oil for feed stock and also oil from the Far East via Trieste. At the end of the war, about 27,000 tons of crude was caught in transit in barges on the Danube and in addition, about 150,000 tons of residuum was available locally in sumps. In all, about ten months' supply of crude and residuum was available to feed this plant.

Construction of the plant was about 70% complete. The cracking plant was short only the reaction chamber which had already been shipped by rail. The construction of the plant started at the end of October, 1944 and work was stopped on 20 April 1945. At this time, there was about six weeks' work left to complete the plant. Construction forces involved up to about 1800 men. The cracking plant had been removed from Fort Jerome. The distillation unit was being moved from Glatz.

- - - - -

Sources of data:

Mr. Fischer, Assistant Chief Engineer,
Deggenauer Refinery, Sueddeutsche Bau, G.m.b.H.

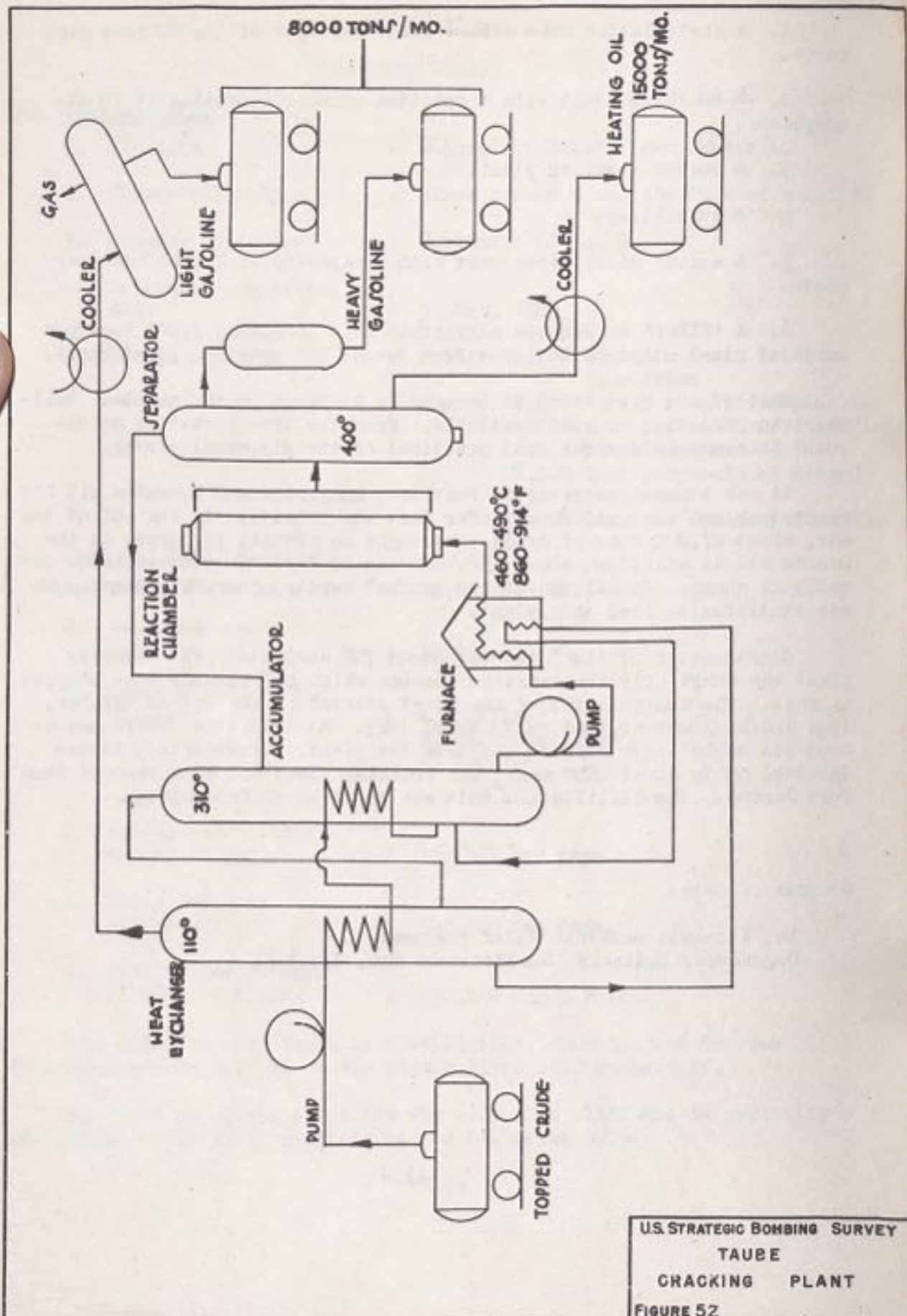

U.S. STRATEGIC BOMBING SURVEY
 TAUBE
 CRACKING PLANT
 FIGURE 52

"TAUBE 2"
(Cracking Plant)

(a) General Data:

- | | | |
|------------------------------|---|--|
| 1. Location | : | Bredelar, near Brilon/Westphalia. |
| 2. Construction type | : | Open construction above ground. |
| 3. Company in charge | : | Wintershall A. G. |
| 4. Estimated completion date | : | 15 May, 1945. |
| 5. Design capacity | : | Feed 6,000 tons per month of residuum from OFENS 1,500 tons per month of gasoline 900 tons per month of diesel fuel 2,700 tons per month of liquefied petroleum gas |

(b) Cost and Labor Required:

- | | | |
|---------------------------------------|---|---|
| 1. Estimated total cost | : | 4,000,000 RM |
| 2. Estimated cost until end of war | : | 3,800,000 RM |
| 3. Average number of workmen | : | a) Skilled 300 b) Unskilled 150 c) Foreign <u>650</u> 1100 |
| 4. Construction labor to end of war | : | 115,000 man days. |
| 5. Total labor to end of war | : | 171,000 man days. |
| 6. Total labor to completion of plant | : | 180,000 man days. |

The cracking unit at Bredelar was a carburel unit which was being moved from Letzkendorf. The unit was originally designed for cracking Fischer Kogasin II (390 - 630° F) and was being converted to feed reduced crude from the "OFENS" at Messinghausen and Muehlenbein. Yields were to be roughly as follows:

| | |
|-------------|-----|
| Naptha | 25% |
| Diesel Oil | 25% |
| Gas | 25% |
| Cracked Tar | 25% |

The gas produced was to be piped to another plant nearby for conversion into alcohol. The code name for this plant was "LACHS".

- - - - -

Sources of data:

Dr. Seyffert, Superintendent of OFENS at Messinghausen and Mushlenbein.

"TAUBE 3"

(Cracking Plant)

The program on this plant was not carried out. The partially completed unit was utilized for the "JAKOB" program as "JAKOB 11".

- - - - -

Small Fischer-Tropsch Plants

(a) General Data:

1. Locations : See next page.
2. Construction type : Built in the open near existing gas works.
3. Companies in charge : See next page.
4. Estimated completion dates : See next page.
5. Design capacity : See page 118.

(b) Cost and Labor Required:

1. Estimated total cost : 12,000,000 RM.
2. Estimated cost to end of war : 7,000,000 RM.
3. Average number of workmen :

| | |
|--------------|------------|
| a) Skilled | 300 |
| b) Unskilled | 300 |
| c) Foreign | <u>450</u> |
| Total | 1050 |
4. Construction labor to end of war : 110,000 man days.
5. Total labor to end of war : 315,000 man day
6. Total labor to completion of plants : 540,000 man days.

| <u>Plant</u> | <u>Location</u> | <u>Company in Charge</u> | <u>Estimated Completion Dates</u> |
|--------------|-----------------------|--------------------------|-----------------------------------|
| Karpfen 1 | Wuerzburg | Gaswerk Wuerzburg | 15 May 1945 |
| 2 | Fuerth | " Fuerth | 1 Jun 1945 |
| 3 | Erfurt | " Erfurt | 1 Jun 1945 |
| 4 | Leipzig | " Leipzig | 1 Jun 1945 |
| 5 | Boehlen | " Boehlen | Finished |
| 6 | Plauen | " Plauen | 15 May 1945 |
| 7 | Chemnitz | " Chemnitz | 15 Jul 1945 |
| 8 | Heidenau near Dresden | " Heidenau | 1 Jul 1945 |
| 9 | Cottbus | " Cottbus | 1 Aug 1945 |
| 10 | Goerlitz | " Goerlitz | 1 Aug 1945 |

These plants (10 in number) are very small Fischer-Tropsch plants built near existing gas works for synthesis of small amounts of oil from water gas.

Coal gas and coke are fed to the water gas generator to produce the proper proportions of CO and H₂ in the synthesis gas.

The synthesis gas is fed through an activated charcoal absorber to pick up hydrocarbons and gum forming constituents, and through an iron oxide absorber for removal of inorganic sulfur.

The gas is then picked up by a blower and passed through a heater to the final absorbers at a temperature of 390° - 480° F. In the absorbers, organic sulfur is removed on alkalinized iron oxide which is produced by Ruhr Chemie for this purpose.

The gas then passes through one or more Fischer ovens in parallel where the synthesis takes place over a cobalt catalyst. The temperature is controlled by generating steam in closely spaced steam coils in the catalyst bed.

A primary separator collects the waxes formed, a water jet condenser condenses the middle and lighter oils, and activated charcoal absorbers remove the remaining gasoline from the gas stream which is fed back to the city gas holder.

All synthetic products are combined in a common tank and shipped elsewhere by railroad for distillation.

The synthesis gas produced at the city gas works is not as good as that produced in the usual Fischer plant, and since these plants have only one stage instead of 2 or 3 as in the usual plant, the yield is considerably lower.

A good Fischer plant will produce 4.0 to 4.3 tons of liquid product per million cubic feet of ideal gas.

The "KARPFEN" produce 1.7 to 2.0 tons/MMcf, or about 45% of the yield of a good plant.

The production per oven, however, is the same as in a good plant since there are no second or third stage ovens operating on lean gas to bring down the average.

Production is one and a half to two tons per day per oven, either in the Karpfen or the larger plants.

All Karpfen plants were designed and were being built by Lurgi. According to Lurgi representatives, the whole Karpfen program of ten (10) installations was a waste of energy and money considering the small output. But Geilenberg insisted on this construction, claiming that if such units were gradually added to all gas works in Germany and they produced only a few tons each, it would add up to a considerable amount, and due to their dispersal they would not be very vulnerable to air attack.

The cost of the Leipzig plant, which is by far the largest of the ten, was estimated as follows:

| | |
|-----------------------|--------------------|
| Equipment erected | 1,200,000 RM. |
| Lines to gas works | 800,000 RM. |
| Ovens and accessories | 800,000 RM.* |
| Foundations | <u>200,000 RM.</u> |
| Total: | 3,000,000 RM. |

*The Fischer ovens for the entire KARPFEN program were to come from Luetzkendorf. The cost of an oven in a new plant is 700,000 RM. In this case, a value of 50,000 RM. was assigned for the used ovens and the balance is transportation, etc.

The cost of the ten Karpfen plants was estimated to be about 12,000,000 RM.

KARPI

(Small Fischer - Tropsch)

| LOCATION | SYNTHETIC GAS PRODUCTION | | | CONSUMPTION (A) COKE OVEN GAS MCF/DAY (B) COKE TONS/DAY (C) STEAM TONS/DAY | GAS STORAGE P GAS HOLDER SIZE (A) FOR WATER GAS (B) FOR CITY GAS MCF |
|----------|--|----------------|---|---|--|
| | CAPACITY OF WATER GAS PRODUCERS EXISTING MCF/DAY | NEW MCF/DAY | SYNTHETIC GAS REQUIREMENT (A) THRU GASSING (B) THRU CRACKING MCF | | |
| KOTTBUS | | 2X847 | (A) 1130 (B) $\frac{565}{1695}$ | (A) 377 (B) 20.8 (C) 19.2 | (A) 106 (B) 176 (B) 283 |
| GÖRLITZ | 1X530 1X495 | 1X847 | (A) 1130 (B) $\frac{565}{1695}$ | (A) 377 (B) 20.8 (C) 19.2 | (A) 71 |
| WÜRZBURG | 1X635 1X424 | 1X1060 | (A) 1130 (B) $\frac{565}{1695}$ | (A) 377 (B) 20.8 (C) 19.2 | (A) 312 + 106 (B) 300 (B) 1060 |
| FÜRTH | 1X424 1X495 | 2X1060 | (A) 1130 (B) $\frac{565}{1695}$ | (A) 377 (B) 20.8 (C) 19.2 | (A) 28 (B) 1060 |
| ERFURT | | 2X847 | (A) 1130 (B) $\frac{565}{1695}$ | (A) 377 (B) 20.8 (C) 19.2 | (A) 424 (B) 424 (B) 530 |
| PLAUEN | 1X847 | 1X847 | (A) 1130 (B) $\frac{565}{1695}$ | (A) 377 (B) 20.8 (C) 19.2 | (A) 106 |
| CHEMNITZ | 3X713 | | (A) 1130 (B) $\frac{565}{1695}$ | (A) 377 (B) 20.8 (C) 19.2 | (A) 51 |
| HEIDENAU | | 2X1200 | (A) 1690 (B) $\frac{850}{2540}$ | (A) 565 (B) 31.2 (C) 28.8 | (A) 71 (B) 351 (B) 1060 |
| BÖHLEN | | | | | (A) 847 |
| LEIPZIG | 2X1425 | 2X3530 | | | |

NUMBER OF GENERATORS

KARPFEN PL

(Small Fischer - Tropsch Plants Attached)

| N | SYNTHETIC GAS PRODUCTION | | | GAS STORAGE PRODUCTION PURIFICATION | | | |
|---|---|-------------|---|--|---|---|---|
| | CAPACITY OF WATER GAS PRODUCERS EXISTING MCF/DAY | NEW MCF/DAY | SYNTHETIC GAS REQUIREMENT (A) THRU GASSING (B) THRU CRACKING M C F | CONSUMPTION (A) COKE OVEN GAS ^{MCF} / DAY (B) COKE TONS/DAY (C) STEAM TONS/DAY | GAS HOLDER SIZE (A) FOR WATER GAS (B) FOR CITY GAS M C F | ROUGH PURIFICATION NUMBER OF PURIFIERS WITH TOTAL VOLUME M C F | FINE PURIFICATION NUMBER OF PURIFIERS AND TOTAL VOLUME M C F |
| | | 2X847 | (A) 1130 (B) 565 <u>1695</u> | (A) 377 (B) 20.8 (C) 19.2 | (A) 106 (B) 176 (B) 283 | 4 BOXES AVAILABLE | 3 X 6' 0.7 M |
| | 1X530 1X495 | 1X847 | (A) 1130 (B) 565 <u>1695</u> | (A) 377 (B) 20.8 (C) 19.2 | (A) 71 | 3 BOXES AVAILABLE 3.5 MCF | 3 X 6' 0.7 M |
| | 1X635 1X424 | 1X1060 | (A) 1130 (B) 565 <u>1695</u> | (A) 377 (B) 20.8 (C) 19.2 | (A) 312+106 (B) 300 (B) 1060 | 3 BOXES AVAILABLE 3.5 MCF | 3 X 6' 0.7 M |
| | 1X424 1X495 | 2X1060 | (A) 1130 (B) 565 <u>1695</u> | (A) 377 (B) 20.8 (C) 19.2 | (A) 28 (B) 1060 | 3 BOXES AVAILABLE 3.5 MCF | 3 X 6' 0.7 M |
| | | 2X847 | (A) 1130 (B) 565 <u>1695</u> | (A) 377 (B) 20.8 (C) 19.2 | (A) 424 (B) 424 (B) 530 | 3 BOXES AVAILABLE 3.5 MCF | 3 X 6' 0.7 M |
| | 1X847 | 1X847 | (A) 1130 (B) 565 <u>1695</u> | (A) 377 (B) 20.8 (C) 19.2 | (A) 106 | 4 BOXES AVAILABLE 6.1 MCF | 3 X 6' 0.7 M |
| | 3X713 | | (A) 1130 (B) 565 <u>1695</u> | (A) 377 (B) 20.8 (C) 19.2 | (A) 51 | 5060 MCF EXISTING | 3 X 10' 1.1 M |
| | | 2X1200 | (A) 1690 (B) 850 <u>2540</u> | (A) 565 (B) 31.2 (C) 28.8 | (A) 71 (B) 351 (B) 1060 | | 3 X 10' 1.1 M |
| | 2X1425 | 2X3530 | | | (A) 847 | 16 BOXES AVAILABLE | |

NUMBER OF GENERATORS

PLANTS

(To City Gas Works)

| PURIFICATION NUMBER OF PURIFIERS TOTAL VOLUME MCF | SYNTHETIC CRUDE PRODUCTION | | | TOTAL FINISHED PRODUCTS ALL PLANTS TONS/MON. |
|--|---|--|--|---|
| | FISCHER OVENS NUMBER AND STEAM GENERATION TONS/DAY | ACTIVATED CHARCOAL ABSORBERS STEAM CONSUMPTION TONS/DAY | SYNTHETIC CRUDE PRODUCTION TONS/MON. | |
| 6" CF | 2 16.5 | 2 X 4' 11" 11.0 TON/DAY | 100 | 350 GASOLINE 420 DIESEL OIL 70 PARAFFIN 420 KOGASIN 140 GAS OIL <hr/> 1400 TOTAL |
| 6" CF | 2 16.5 | 2 X 4' 11" 11.0 TON/DAY | 100 | |
| 6" CF | 2 16.5 | 2 X 4' 11" 11.0 TON/DAY | 100 | |
| 6" CF | 2 16.5 | 2 X 4' 11" 11.0 TON/DAY | 100 | |
| 5" CF | 2 16.5 | 2 X 4' 11" 11.0 TON/DAY | 100 | |
| 5" CF | 2 16.5 | 2 X 4' 11" 11.0 TON/DAY | 100 | |
| 10" F | 2 POSSIBLY 3 16.5 | 3 X 4' 11" 17.25 TON/DAY | 100 | |
| 10" F | 3 25.0 | 3 X 4' 11" 17.25 TON/DAY | 150 | |
| | 1 LURGI | | 50 | |
| | 12 WINTERSHALL | 3 X 7' 8" | 500 | |

FIGURE 54

The cost of the individual installations varied considerably depending on local conditions, the amount of CO and H₂ on hand, amount of piping required, etc.

None of the KARFFEN plants are underground. These little plants, with an average planned production of 100 tons of crude per month (except Leipzig, with about 500 tons per month) were in the Geilenberg emergency construction program to partly offset the damage done by air raids to large Fischer-Tropsch plants like Luetzkendorf. Figure 54 lists all KARFFEN plants, their characteristics and proposed capacities.

The Leipzig plant was about 80% completed at the end of the war and construction was continued on orders of the Allied Military Government.

These standard ovens are about 66 inches wide, about 8 to 9 feet high and 18 feet long.

- - - - -

Sources of data:

W.L. Ruckes, Construction Engineer for Lurgi
Gesellschaft fuer Waermetechnik m.b.H., Frankfurt.

Dr. Hulman, Director of the Technical Bureaus of Lurgi.

Dr. Hamborg, Assistant Plant Manager of the Leipzig
Gas Works.

Mr. E. Geilenberg.

"JAKOB 1"

(Primitive Cracking Plant)

(a) General Data:

1. Location : Stanzendorf County, St. Poelten/Lower Danube.
2. Construction type : Open construction above ground.
3. Company in charge : Donau-Chemie.
4. Estimated completion date : 11 June 1945 (originally 15 April 1945).
5. Design capacity : Raw Material: Residuum from Brown Coal tar, after distilling off the light and middle oils.
Feed: 3,000 tons per month of heavy oils.
Production: (in tons per month)
750 Crude Gasoline
600 Crude Diesel Fuel
450 Fuel Oil
900 Pitch
6. Cracking process : Hoffman

(b) Cost and Labor Required:

1. Estimated total cost : 2,900,000 RM.
2. Estimated cost until end of war : 700,000 RM.
3. Average number of workmen :

| | |
|--------------|------------|
| a) Skilled | 100 |
| b) Unskilled | 100 |
| c) Foreign | <u>300</u> |
| Total | 500 |
4. Construction labor to end of war : 35,000 man days.
5. Total labor to end of war : 35,000 man days.
6. Total labor to completion of plant : 85,000 man days.

JAKOB 2

(Primitive Cracking Plant)

(a) General data:

1. Location : Hirschfelde, north-east of Zittau/Sa.
2. Construction type : Open construction above ground.
3. Company in charge : ASW.
4. Estimated completion date : 15 June, 1945.
5. Design capacity : Feed: 3,000 tons per month of heavy oils.
Production: (in tons per month)
750 Crude Gasoline
600 Crude Diesel Fuel
450 Fuel Oil
900 Pitch
6. Cracking process : Hoffman

(b) Construction Cost and Labor Required:

1. Estimated total cost : 1,900,000 RM.
2. Estimated cost until end of war : 900,000 RM.
3. Average number of workmen : a) Skilled 50
b) Unskilled 50
c) Foreign 150
Total 250
4. Construction labor to end of war : 33,000 man days.
5. Total labor to end of war : 40,000 man days.
6. Total labor for completion of plant : 85,000 man days.

"JAKOB 3"

(Primitive Cracking Plant)

(a) General Data:

1. Location : Berbersdorf-north, near Hainichen/Saxony.
2. Construction type : Open construction above ground.
3. Company in charge : ASW.
4. Estimated completion date : 27 May, 1945 (originally 30 March, 1945).
5. Design capacity : Feed: 3,000 tons per month of heavy oils.
Production: (in tons per month)
750 Crude Gasoline
600 Crude Diesel Fuel
450 Fuel Oil
900 Pitch
6. Cracking process : Hoffman

(b) Cost and Labor Required:

1. Estimated total cost : 1,900,000 RM.
2. Estimated cost until end of war : 1,800,000 RM.
3. Average number of workmen :

| | |
|--------------|------------|
| a) Skilled | 100 |
| b) Unskilled | 150 |
| c) Foreign | <u>250</u> |
| Total | 500 |
4. Construction labor to end of war : 50,000 man days.
5. Total labor to end of war : 81,000 man days.
6. Total labor to completion of plant : 86,000 man days.

"JAKOB 4"

(Primitive Cracking Plant)

(a) General Data:

1. Location : Berbersdorf-south, near Hainichen? Saxony.
2. Construction type : Open construction above ground.
3. Company in charge : ASW.
4. Estimated completion date : 15 June, 1945 (originally 15 April 1945).
5. Design capacity : Feed: 3,000 tons per month of heavy oils.
Production: (in tons per month)
750 Crude Gasoline
600 Crude Diesel Fuel
450 Fuel Oil
900 Pitch
6. Cracking process : Hoffman

(b) Cost and Labor Required:

1. Estimated total cost : 1,900,000 RM.
2. Estimated cost until end of war : 1,100,000 RM.
3. Average number of workmen : a) Skilled 50
b) Unskilled 100
c) Foreign 150
Total 300
4. Construction labor to end of war : 34,000 man days.
5. Total labor to end of war : 50,000 man days.
6. Total labor to completion of plant : 85,000 man days.

"JAKOB 5"

(Primitive Cracking Plant)

(a) General Data:

1. Location : Boegerhof near Rinteln on the Weser.
2. Construction type : Open construction above ground.
3. Company in charge : Nerag.
4. Estimated completion date : 1 July 1945 (originally 30 April 1945).
5. Design capacity : Feed: 3,000 tons per month of heavy oils.
Production: (in tons per month)
750 Crude Gasoline
600 Crude Diesel Fuel
450 Fuel Oil
900 Pitch
6. Cracking process : Hoffman

(b) Cost and Labor Required:

1. Estimated total cost : 1,900,000 RM.
2. Estimated cost until end of war : 1,100,000 RM.
3. Average number of workmen : a) Skilled 50
b) Unskilled 50
c) Foreign 200
Total 300
4. Construction labor to end of war : 31,000 man days.
5. Total labor to end of war : 50,000 man days.
6. Total labor to completion of plant : 85,000 man days.

JAKOB 6

(Primitive Cracking Plant)

(a) General Data:

1. Location : Braunsdorf near Altenburg/Thuringia.
2. Construction type : Open construction above ground.
3. Company in charge : DEA.

(b) Construction Cost and Labor Required:

Planning was stopped before construction was started.

JAKOB 7

(Primitive Cracking Plant)

(a) General Data:

1. Location : Gross-Stoebnitz on the Sprotte/Thuringia.
2. Construction type : Open construction above ground.
3. Company in charge : Riebeck-Montan.

(b) Construction Cost and Labor Required:

The project was abandoned.

JAKOB 8

(Primitive Cracking Plant)

(a) General Data:

1. Location : Kammerforst near Haselback/Thuringia.
2. Construction type : Open construction above ground.
3. Company in charge : I.G. Farben.

(b) Construction Cost and Labor Required:

Planning was stopped before construction was started.

"JAKOB 9"

(Primitive Cracking Plant)

(a) General Data:

1. Location : Hedersleben near Halberstadt.
2. Construction type : Open construction above ground.
3. Company in charge : Rheinpreussen.
4. Estimated completion date : 30 May, 1945 (originally 30 April 1945)
5. Design capacity : Feed: 2,000 tons per month of heavy oils.
Production: (in tons per month)
500 Crude Gasoline
500 Crude Diesel Fuel
720 Pitch
80 Fuel Gas
6. Cracking process : Carburol

(b) Cost and Labor Required:

1. Estimated total cost : 1,000,000 RM.
2. Estimated cost until end of war : 700,000 RM.
3. Average number of workmen : a) Skilled 50
b) Unskilled 50
c) Foreign 150
Total 250
4. Construction labor to end of war : 24,000 man days.
5. Total labor to end of war : 31,000 man days.
6. Total labor to completion of plant : 50,000 man days.

"JAKOB 10"

(Primitive Cracking Plant)

(a) General Data:

1. Location : Mariannensglueck County, Senftenberg/Niederlausitz.
2. Construction type : Open construction above ground.
3. Company in charge : Anhaltische Kohlenwerke.
4. Estimated completion date : 15 June, 1945 (originally 30 March 1945)
5. Design capacity : Feeds: 4,000 tons per month of heavy oils.
Production: (in tons per month)
1,000 Crude Gasoline
1,000 Crude Diesel Fuel
1,440 Pitch
160 Fuel Gas
6. Cracking process : Carburol

(b) Cost and Labor Required:

1. Estimated total cost : 1,900,000 RM.
2. Estimated cost until end of war : 600,000 RM.
3. Average number of workmen : a) Skilled 50
b) Unskilled 50
c) Foreign 150
Total 250
4. Construction labor to end of war : 25,000 man days.
5. Total labor to end of war : 27,000 man days.
6. Total labor to completion of plant : 85,000 man days.

"JAKOB 11" (formerly Taube 3)

(Primitive Cracking Plant)

(a) General Data:

1. Location : Mine ADA/Lausitz.
2. Construction type : Open construction above ground.
3. Company in charge : Brabag.
4. Estimated completion date : - - - (originally 30 April 1945).

(b) Cost and Labor Required:

The construction was only being started.

- - - - -

Sources of data:

All data on Jakob program was obtained from:

Mr. E. Geilenberg.

"KUGELOFEN"

(Cracking Plants)

1. Construction type : Above ground, in concealed locations.
2. Capacity : 700 tons per month of reduced crude per plant.

These units for light cracking were to be built from salvaged material from bombed plants. Twenty-two plants were planned and equipment for 20 of them was to be removed from the following bombed plants:

| <u>KUGELOFEN</u> | <u>Taken from</u> |
|------------------|-------------------|
| 3 | Foelitz |
| 8 | Gelsenberg |
| 6 | Scholven |
| <u>3</u> | Blechhammer |
| 20 | |

Sources of data:

Files of Professor Krauch, Commissioner General for Problems of the Chemical Industry.

PLANT "DACHS 1"

(a) General Data:

1. Location : Porta Westphalica.
2. Construction type : New underground plant.
3. Company in charge : Nerag.
4. Estimated completion date : May 15, 1945.
5. Design capacity : See page 152.

(b) Cost and Labor Required:

1. Estimated total cost : 27,000,000 RM.
2. Estimated cost until end of war : 26,000,000 RM.
3. Average number of workmen :

| | |
|--------------|------|
| a) Skilled | 550 |
| b) Unskilled | 1250 |
| c) Foreign | 500 |
| Total | 2300 |
4. Construction labor : 628,000 man days.
5. Total labor : 1,220,000 man days.

(c) Excavation Required:

1. Area : 48,000 sq. ft.
2. Volume : 46,000 cu. yds.

(d) Capacity: : 9,000 tons per month topped crude.

DACHS 1 is a complete lube oil distillation and treating plant located underground in tunnels dug out of sandstone in a cliff directly opposite to the Porta railroad station.

The plant proper consists of:

- (1) A two-stage vacuum distillation unit taking 3 side cuts on the primary unit and one on the secondary unit. (Lummus design)
- (2) A furfural treating plant (copied from the Texaco furfural unit at Misberg).

(3) Hot clay contact plant (Texaco design).

(4) A dichlorethane dewaxing plant (Edeleanu design).

This is a very pretentious plant and apparently no concessions were made to its unusual environment other than in the actual layout. That is, the plant is in no sense a makeshift but was planned as a permanent installation and contains all the features normally found in such a plant. The plant was built in a sandstone quarry and a minor existing tunnel was extended to provide room for the plant and tankage.

The two vacuum units and the clay contact plant were moved from the Berag refinery at Misberg, while the furfural and the dewaxing unit were new.

The plant was designed for topped crude only because of the additional fire hazard of handling gasoline.

Construction was started on the tunnel in July, 1944, and the installation of equipment was started in September, 1944, with a completion date set by Geilenberg of November, 1944. The plant was about 80% complete in March, 1945, when construction was stopped. It is estimated that the plant would have been completed in May, 1945.

UTILITIES:

Steam was to be provided by two 600 lb. boilers of approximately 65,000 lbs. per hour capacity. One of the boilers was installed outside temporarily to save time in getting the plant started, but was to be moved inside after the underground boiler was in operation.

Electric power. Approximately 3,000 kilowatts of electric power were brought in by underground cable and the transformer station is installed underground.

Cooling water is provided by four centrifugal pumps in two separate concrete pump houses on the banks of the Weser. The pumps are in a pit about 20 feet deep with suction lines running out to the water. The plant would operate at full rate on one pump house except in the summer when high water temperature would increase consumption.

Ventilation is provided to reduce the hazard of building up explosive mixtures at any point in the system. The ventilating blowers were to be installed at the extreme rear of the tunnels, taking suction on the transportation and tank tunnels and discharging through the two plant tunnels. The furnace rooms and the ammonia compressor rooms were to be ventilated separately and isolated from the rest of the system.

Fire fighting equipment was to be entirely conventional and no remote fire control was contemplated.

TANKAGE:

Underground tankage is provided in the tunnels for all unfinished products. That is, tanks were constructed by lining the tunnel walls and floors with brick and concrete and installing bulk heads of reinforced concrete to divide the tunnels into separate tanks. Tankage is installed for untreated spindle oil and light and heavy cylinder oil, as these must be run through the treating plants in turn. Sufficient tankage is provided so that only 2 or 3 switches per month are required. Topped crude and finished product storage is provided in a wooded section on the side of the hill.

LOADING RACKS:

Two racks were provided for unloading about 10 tons of topped crude simultaneously and one for loading finished products. In addition, facilities were planned for loading products into barges on the river.

- - - - -

Sources of data:

Mr. E. Geilenberg

Dr. Zorn - I.G. Farben, Leuna.

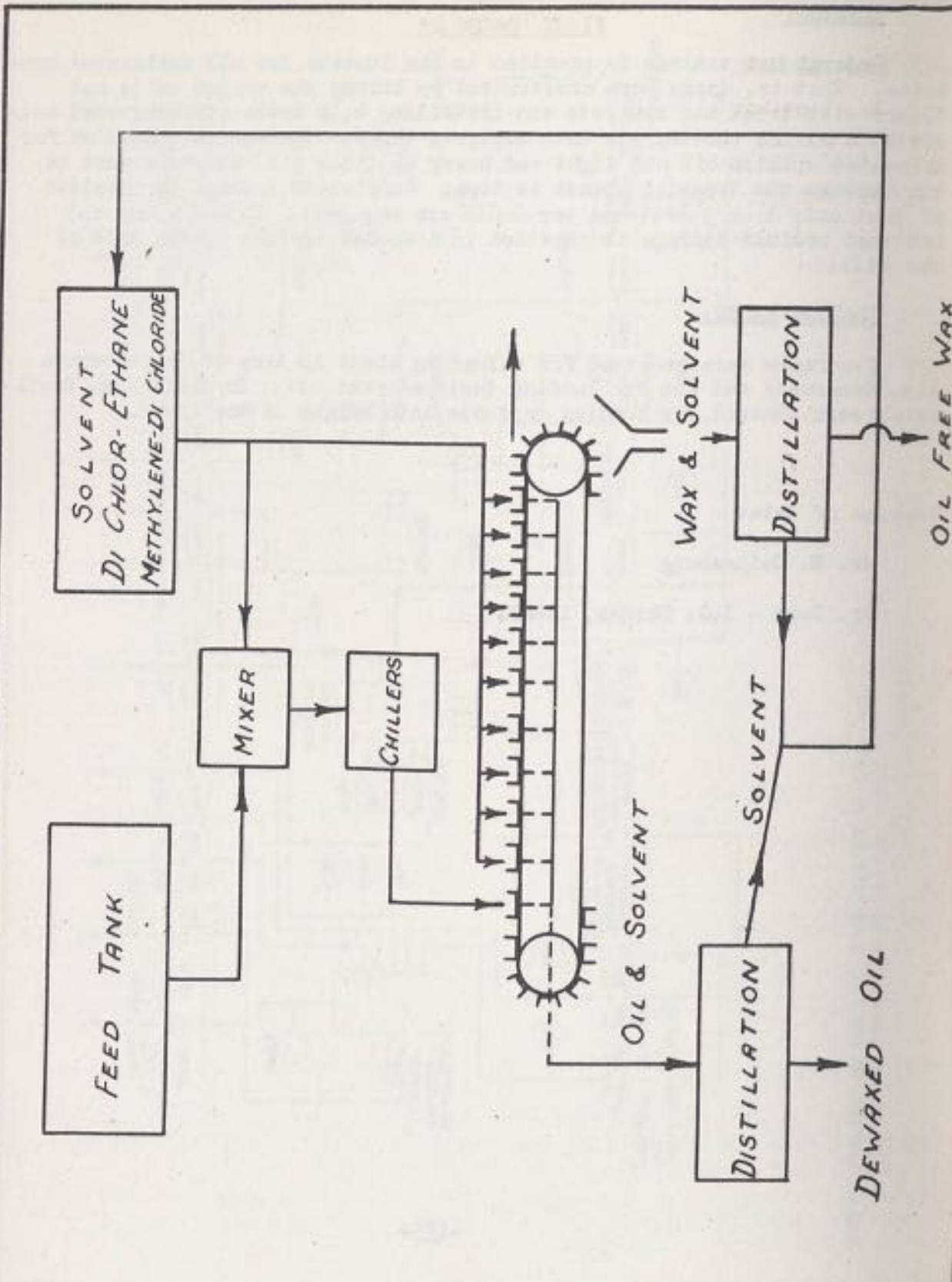

U.S. STRATEGIC BOMBING SURVEY
 EDELANU DEWAXING PLANT
 FIGURE 56

PLANT "DACHS 2"

(a) General Data:

1. Location : Ebensee on Traunsee/Upper Danube.
2. Construction type : New underground plant.
3. Company in charge : DEA
4. Estimated completion date : 1 August, 1945.
5. Design capacity : See page 152.

(b) Cost and Labor Required:

1. Estimated total cost : 40,000,000 RM.
2. Estimated cost until end of war : 30,000,000 RM.
3. Average number of workm.
 - a) Skilled 1,100
 - b) Unskilled 1,800
 - c) Foreign 1,700
 - Total 4,600
4. Construction labor to end of war : 682,000 man days.
5. Total labor to end of war : 1,350,000 man days.
6. Total labor to complete plant : 1,800,000 man days.

(c) Excavation Required:

1. Area : 260,000 sq. ft.
2. Volume : 280,000 cu. yds.

(d) Capacity:

: 8400 tons per month, topped crude.

This plant was to consist of vacuum distillation and Duo-sol extraction, sulfuric acid treatment, clay treatment and dewaxing. Little has been done on the installation of the treating equipment. However, 8 "ofens" with a total capacity of 24,000 tons per month were in operation underground at this location.

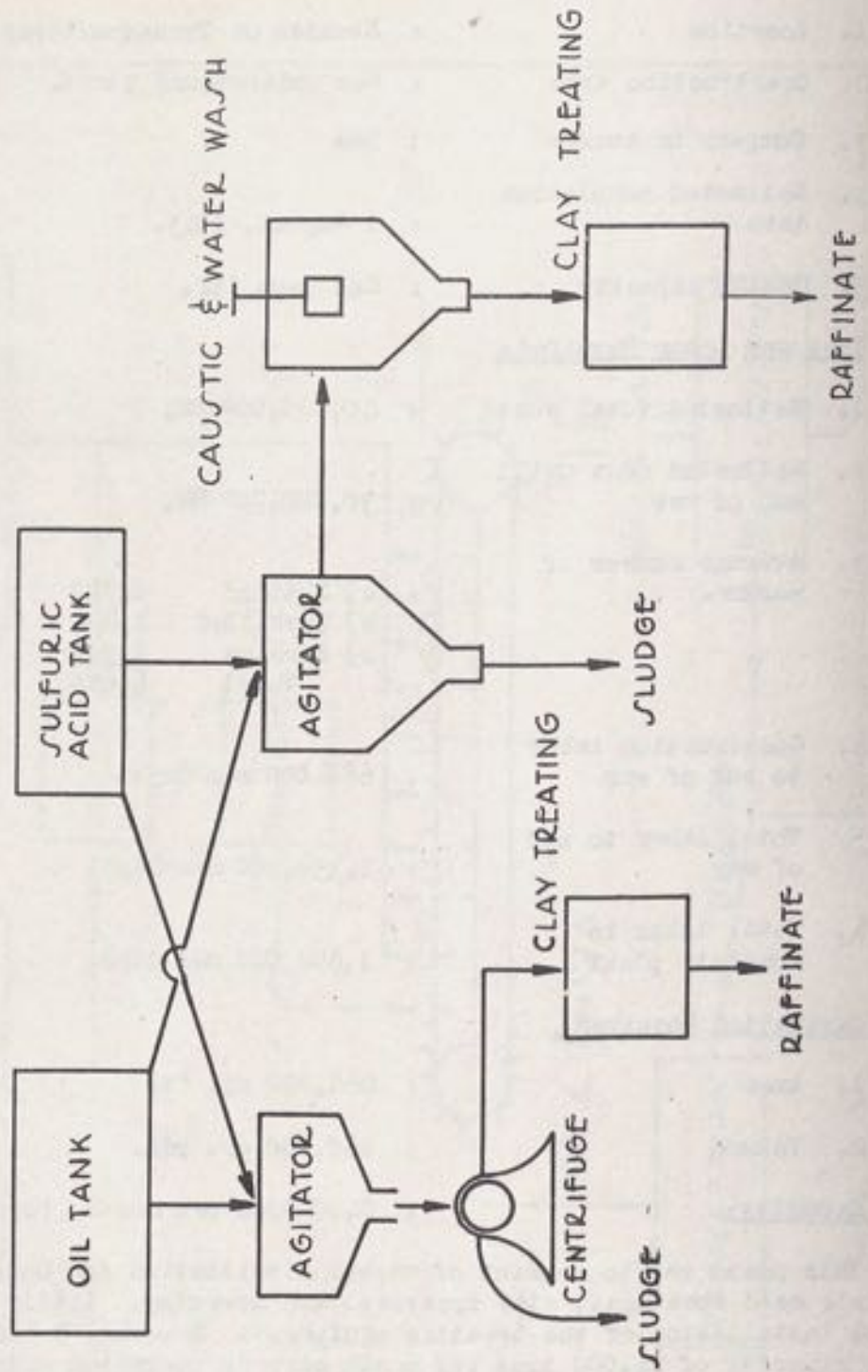

U.S. STRATEGIC BOMBING SURVEY
 SULFURIC ACID TREATING
 FIGURE 57

The dewaxing plant was to be new, of Edeleanu design with band filters and a capacity of 4,000 tons per month.

The Duo-sol plant (capacity 6,000 - 7,500 T/mo) was being moved from Livorno, Italy.

The residue from the vacuum distillation and the lube oil extract was to be burned for fuel.

- - - - -

Sources of data:

Mr. Geilenberg

Dr. Zorn - I.G. Farben, Leuna.

PLANT "DACHS 3"

(a) General Data:

1. Location : Deutsch-Brod/Bohemia and Moravia (Protectorate).
2. Construction type : Railway tunnel under construction, finished for the greatest part.
3. Company in charge : Fanto-Werke.
4. Prospective completion date : 1 August, 1945.
5. Design capacity : See page 152.

(b) Cost and Labor Required:

1. Estimated total cost : 9,000,000 RM.
2. Estimated cost until end of war : 4,500,000 RM.
3. Average number of workmen :

| | |
|--------------|------------|
| a) Skilled | 450 |
| b) Unskilled | 50 |
| c) Foreign | <u>500</u> |
| Total | 1000 |
4. Construction labor to end of war : 118,000 man days.
5. Total labor to end of war : 202,000 man days.
6. Total labor to complete plant : 405,000 man days.

(c) Excavation Required:

1. Area : 54,000 sq. ft.
2. Volume : 52,000 cu. yds.

(d) Capacity: : 3,000 tons per month.

This plant was to be built in a railroad tunnel and would have been finished in about 4 months. The equipment was being moved from the Fanto works in Pardubitz.

The plant was to use the SNP (Suida Nobel Foell) process, which consists of Cresol extraction and centrifuging with step-wise separation by water addition. In addition, there was to be a Barisol centrifugal dewaxing, using a dichlorethane-benzol solvent and propene de-asphalting.

Feed was to be provided from two to three "OFENS" and the balance was to come from the Fanto refinery at Pardubitz.

- - - - -

Sources of data:

Mr. E. Geilenberg

Dr. Zorn - I.G. Farben, Leuna.

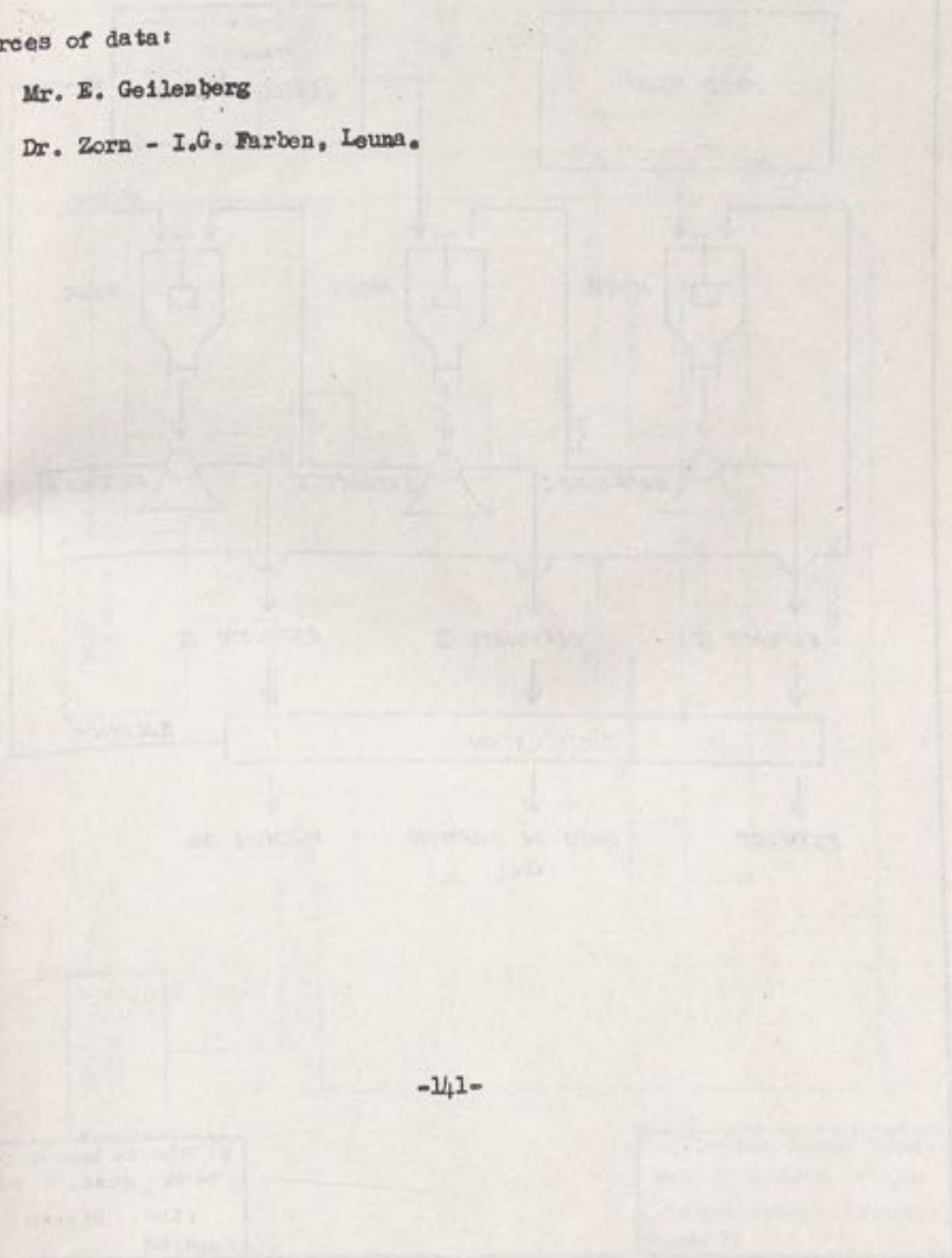

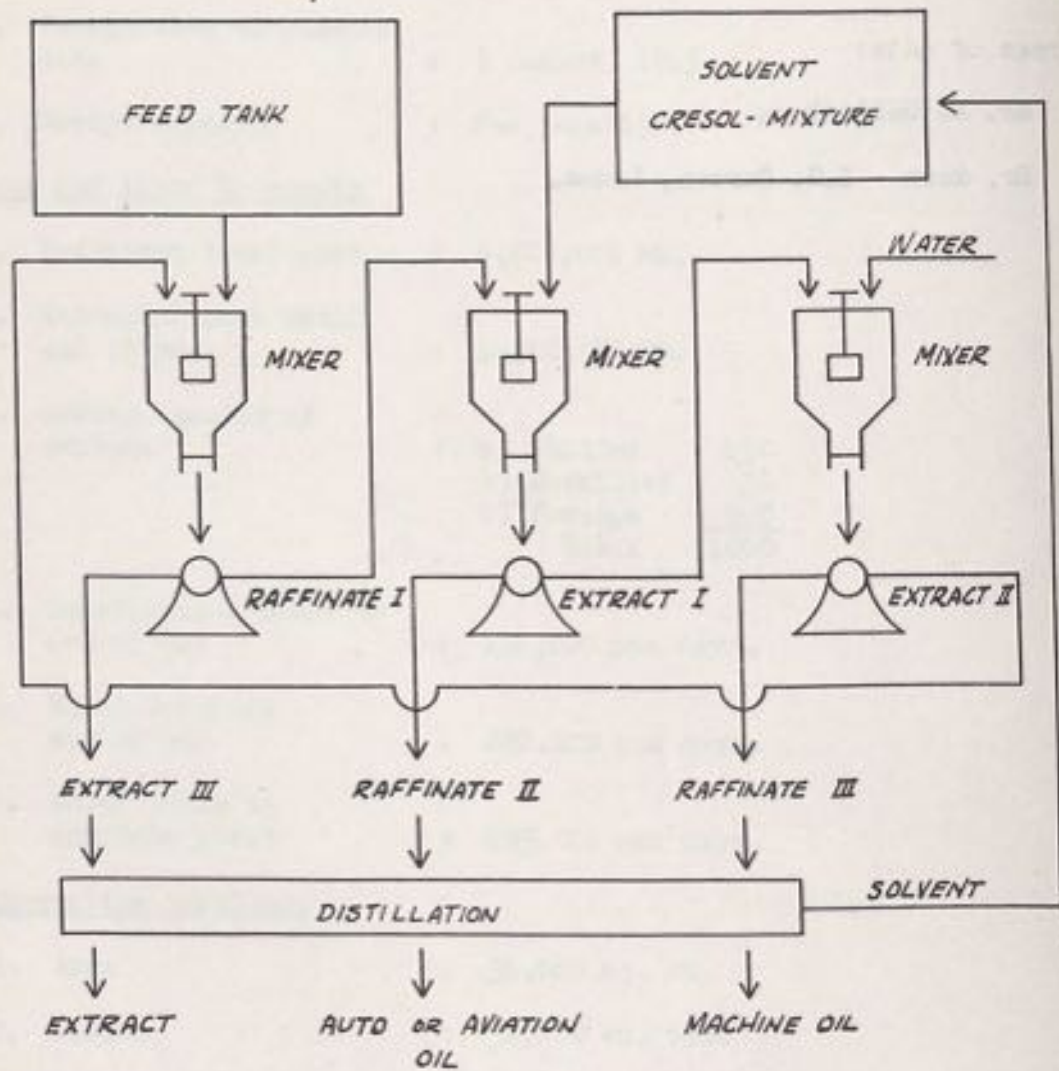

U.S. STRATEGIC BOMBING SURVEY
 SUIDA - NOBEL - PÖLL -
 (SNP) DEWAXING
 FIGURE 58

PLANT "DACHS 4"

(a) General Data:

1. Location : Osterode/Harz.
2. Construction type : New underground plant.
3. Company in charge : Rhenania-Ossag.
4. Estimated completion date : 1 February, 1946.
5. Design capacity : See page 152.

(b) Cost and Labor Required:

1. Estimated total cost : 40,000,000 RM.
2. Estimated cost until end of war : 10,000,000 RM.
3. Average number of workmen :

| | |
|--------------|-------------|
| a) Skilled | 950 |
| b) Unskilled | 250 |
| c) Foreign | 2150 |
| Total | <u>3350</u> |
4. Construction labor to end of war : 333,000 man days.
5. Total labor to end of war : 450,000 man days.
6. Total labor to complete plant : 1,800,000 man days.

(c) Excavation required:

1. Area : 180,000 sq. ft.
2. Volume : 200,000 cu. yds.

(d) Capacity: : 25,000 tons per month crude.

This was to be an underground installation with equipment moved from Rhenania-Ossag refineries at Harburg and Grasbrook. It was to consist of topping stills of 30,000 tons per month capacity; vacuum stills of 15,000

tons per month capacity; dewaxing, sulfuric acid and clay treating. In addition, a small wax cracking and synthetic lube oil plant was to be installed with a capacity of 450 tons per month. The excavation was about 30% complete.

- - - - -

Sources of data:

Mr. E. Geilenberg.

Dr. Zorn - I.G. Farben, Leuna.

LUBRICATING OIL SYNTHESIS

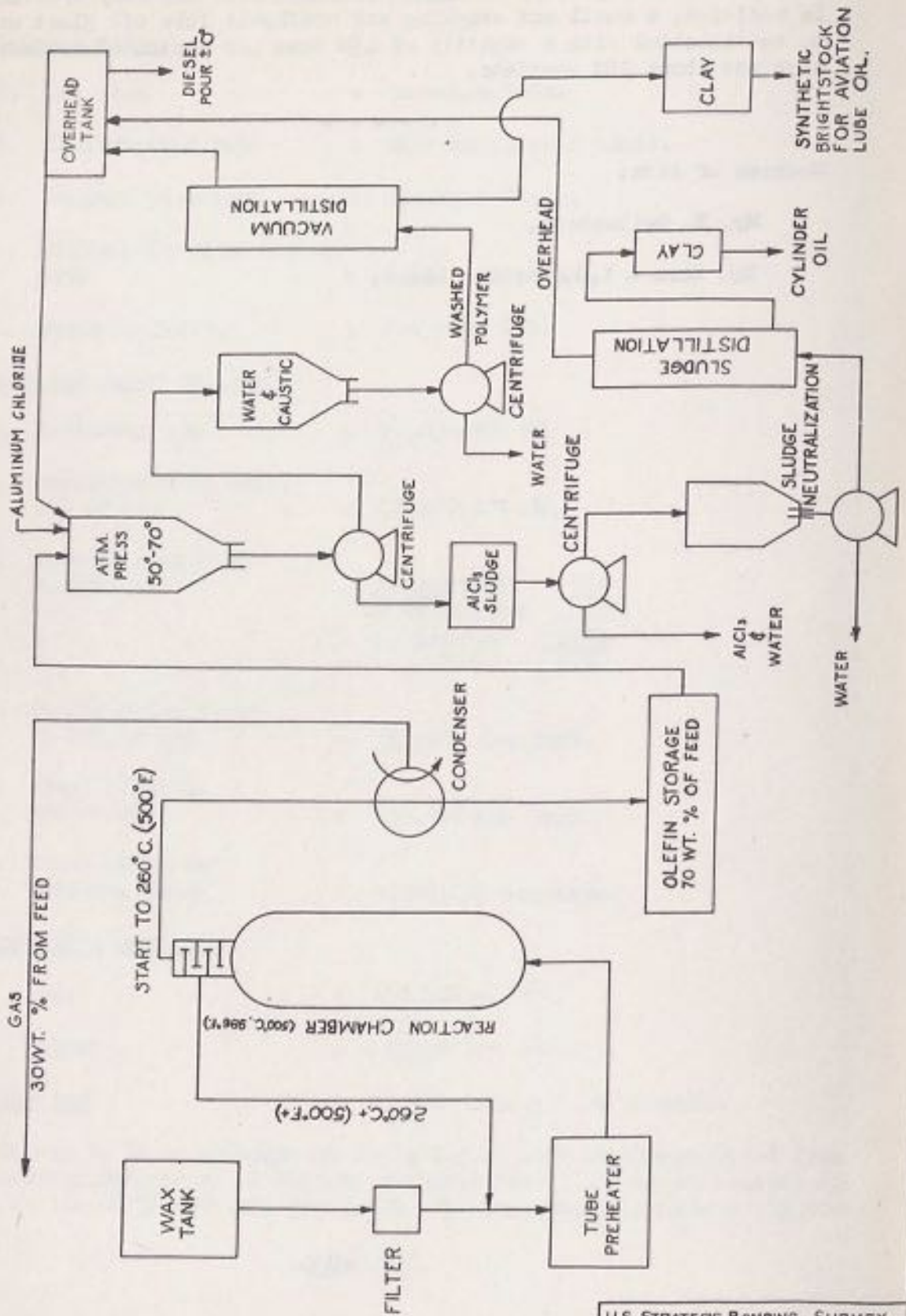

U.S. STRATEGIC BOMBING SURVEY
 LUBRICATING OIL SYNTHESIS
 FIGURE 60

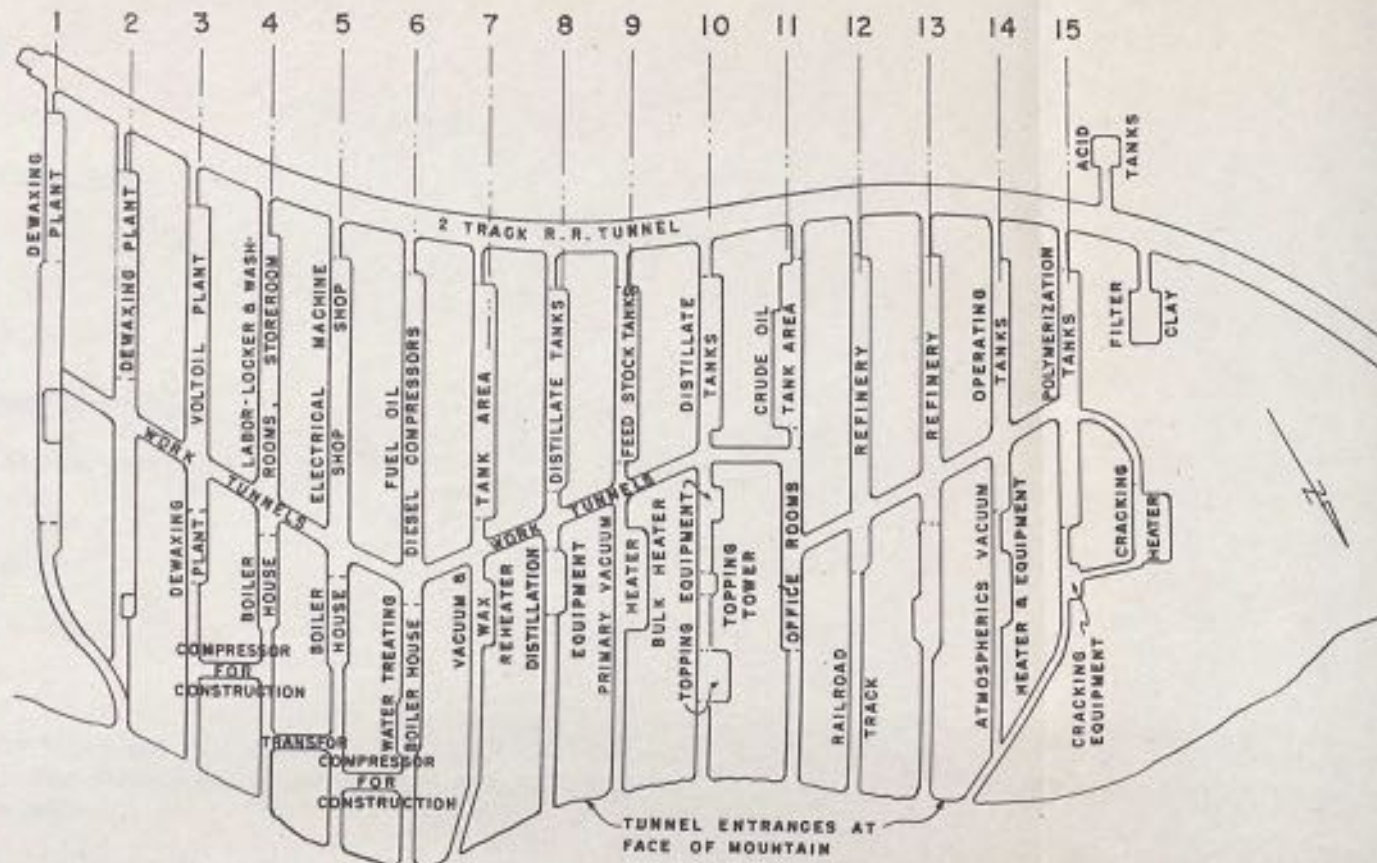

GENERAL PLAN

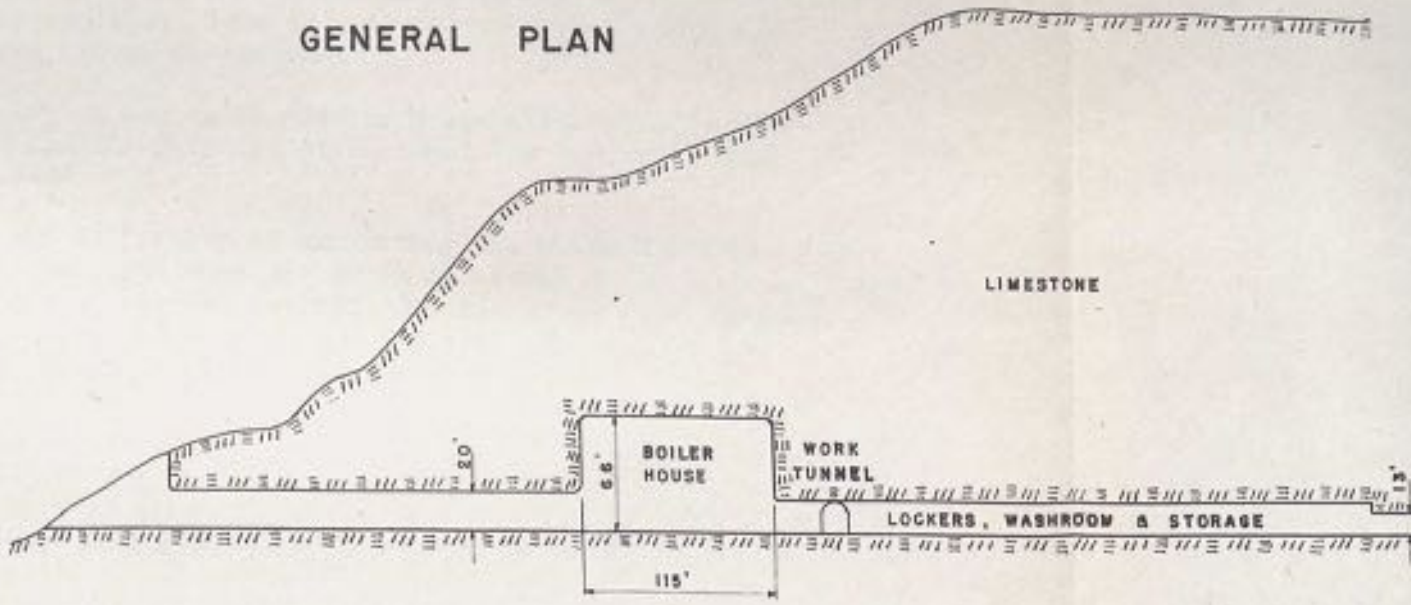

SECTION 4

NO SCALE

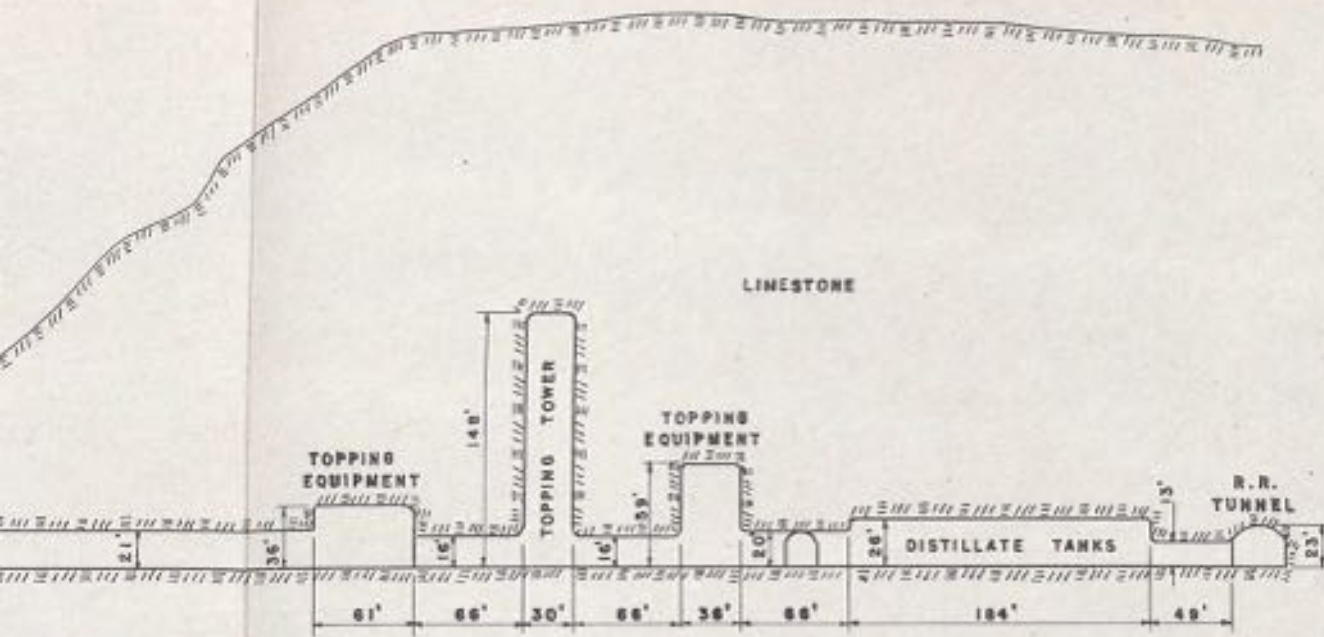

SECTION 10

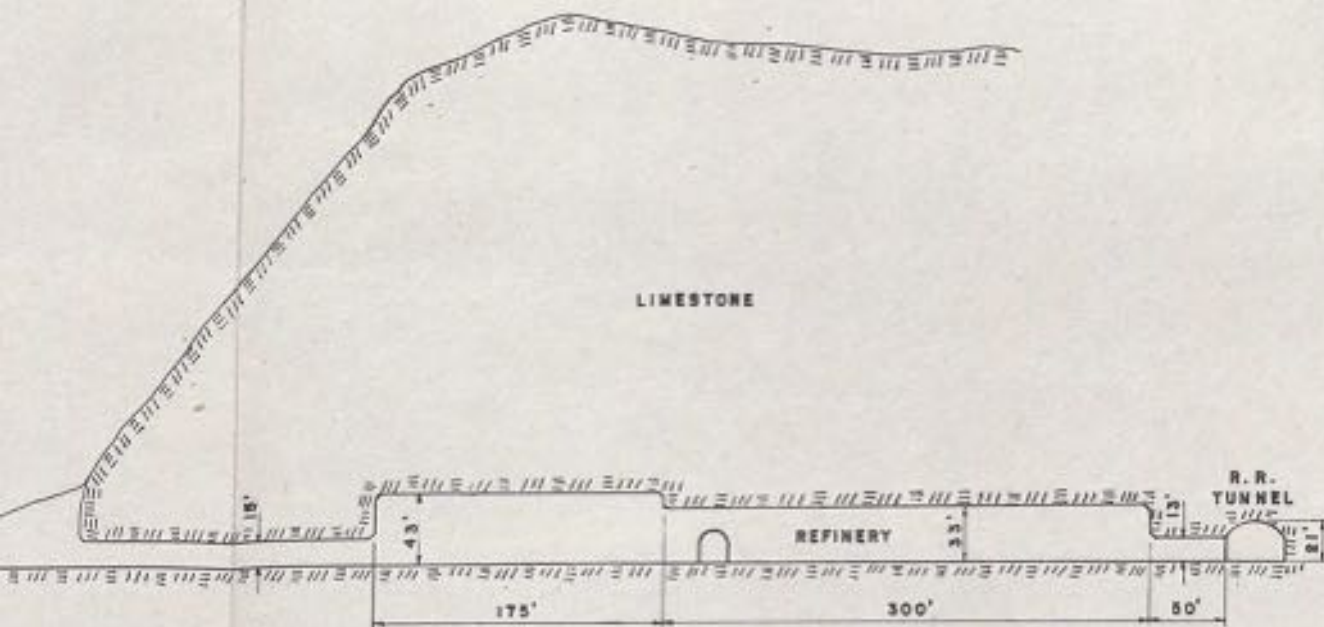

SECTION 13

U.S. STRATEGIC BOMBING SURVEY
 UNDERGROUND REFINERY
 DACHS IV
 OSTERODE HARZ.

FIGURE 61

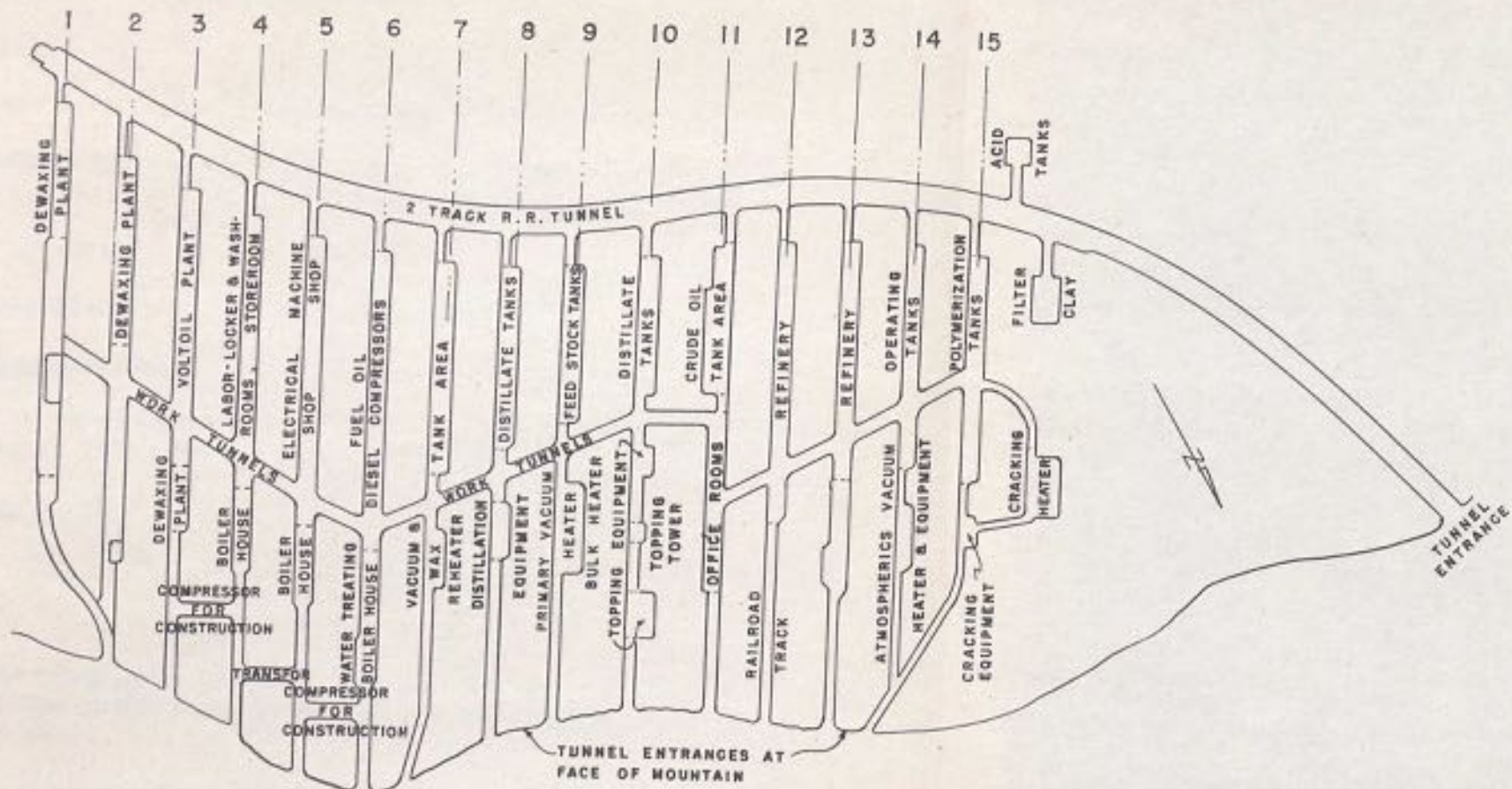

GENERAL PLAN

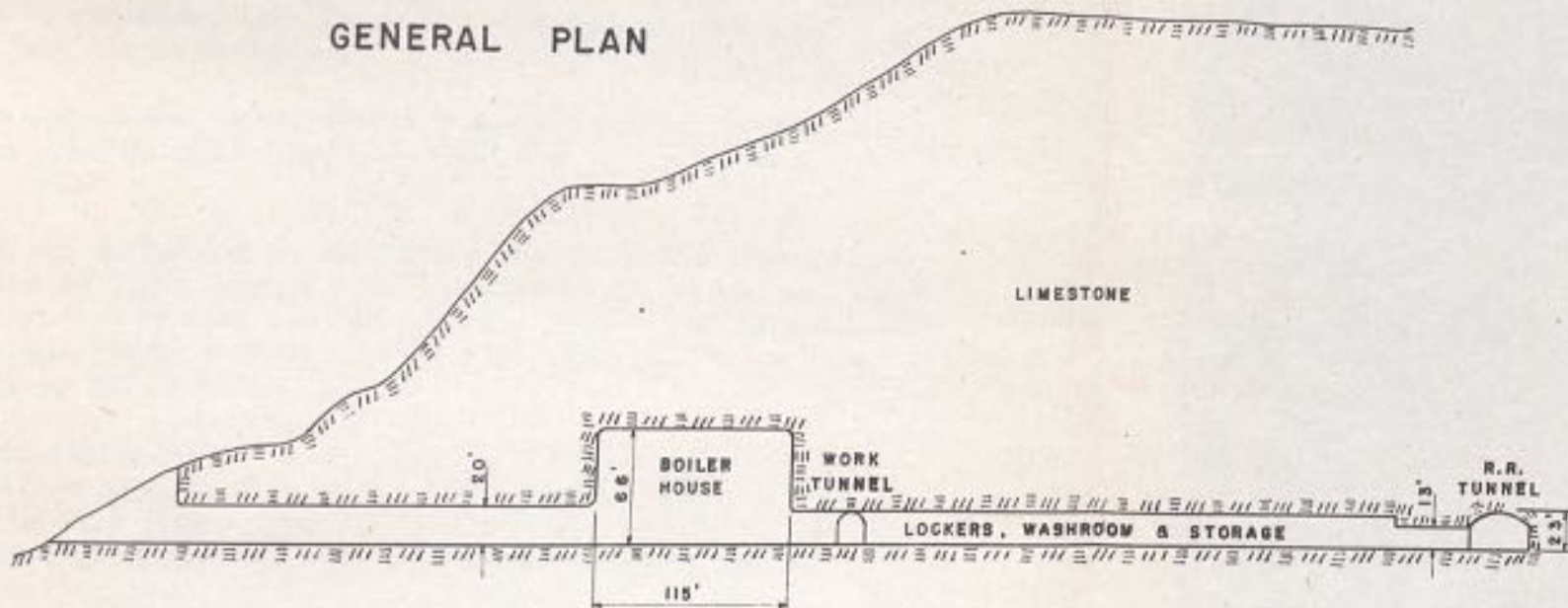

SECTION 4

NO SCALE

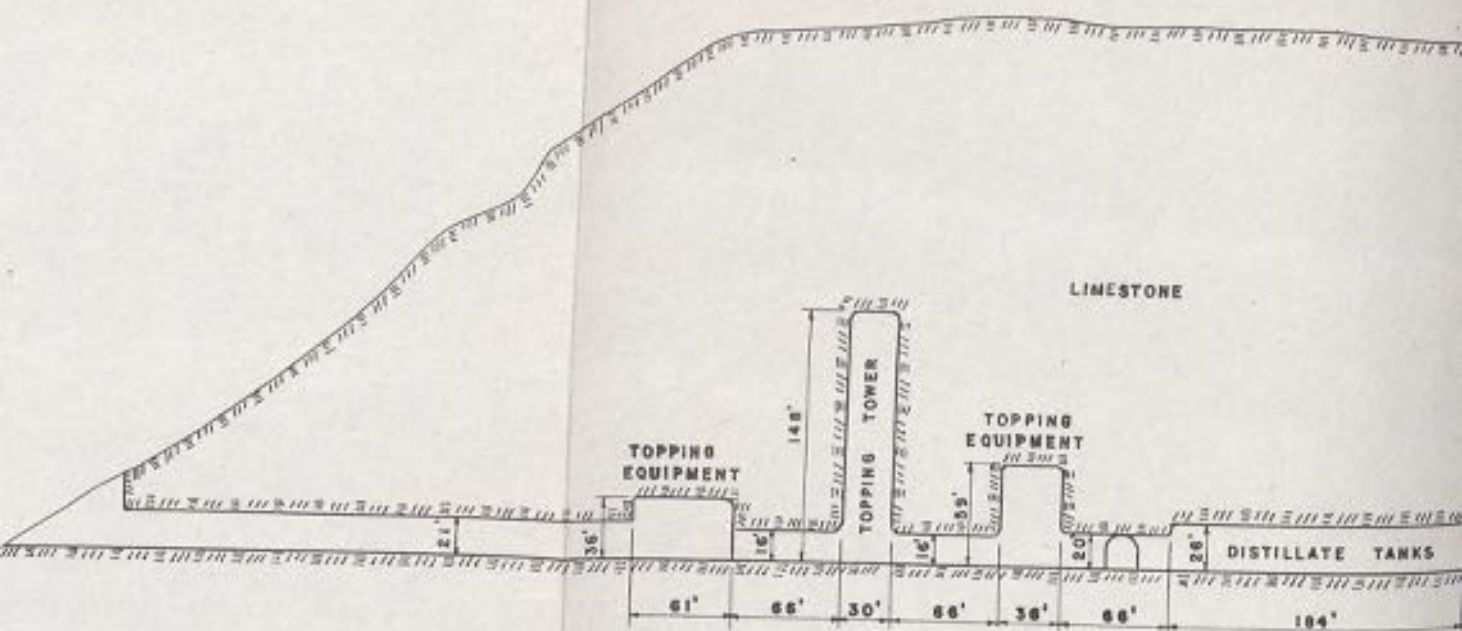

SECTION 10

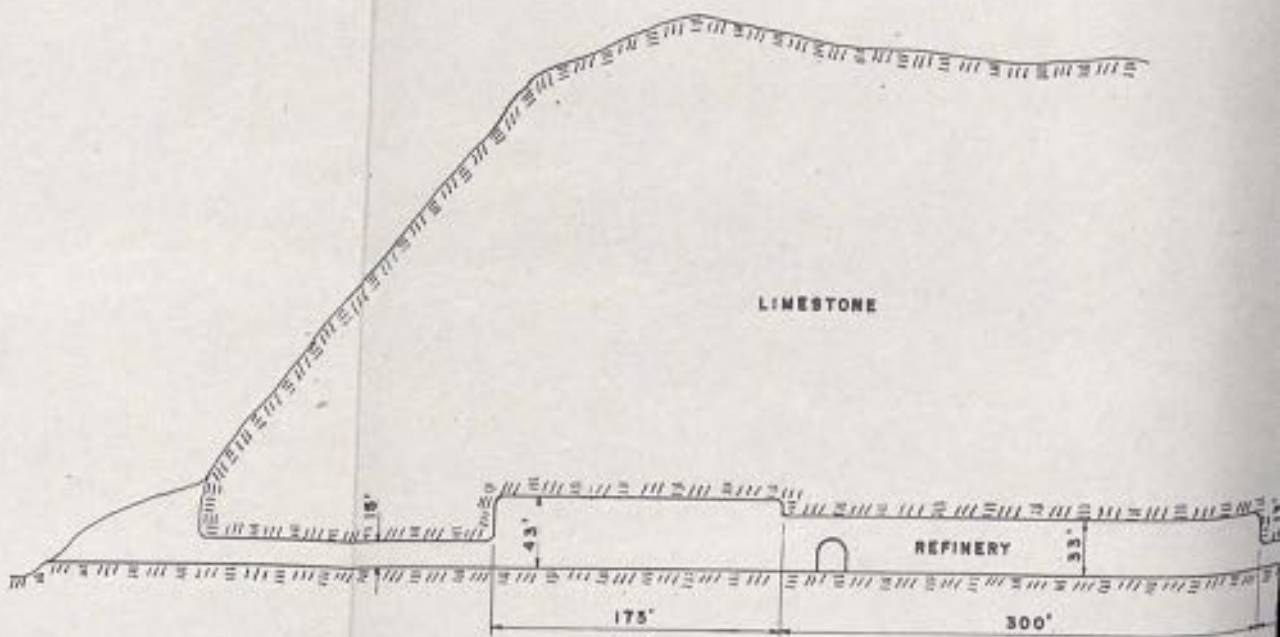

SECTION 13

U.S. STRATEGIC
 UNDERGROUND
 DISTILLATION
 PROCESSING

FIGURE 61

PLANT "DACHS 5"

(a) General Data:

1. Location : Willingen/Waldeck.
2. Construction type : Underground. Planned to enlarge existing slate mines.
3. Company in charge : Ruhr Chemie.
4. Design capacity : See page 152.

(b) Cost and Labor Required:

Very little had been accomplished on this plant because of difficulties with excavating. No labor statistics are available.

(c) Excavation Required:

1. Area : 57,000 sq. ft.
2. Volume : 48,000 cu. yds.

This plant was planned in October, 1944 and was to be finished January 31, 1945. The excavation was to be made as an extension of an abandoned shale mine.

As originally planned, the plant was to have a capacity of 30,000 tons per month of synthetic lube oil, to be produced from Fischer Kogasin to be shipped from Holten-Oberhausen.

This installation was to consist of 3 cracking units for Kogasin and an aluminum chloride polymerization plant for the production of synthetic lube oils.

Because of the difficulty in excavating the shale the size of the plant was reduced to 7,500 tons per month of charge in January and later the lube oil plant was dropped entirely and the project was reduced to removing 2 cracking plants from Salzbergen (120 tons per day) and one from Livorno, Italy (200 tons per day).

Considerable difficulty was encountered with caving of the shale formation, so little progress was made. The attack on the mining problem appeared to be very poorly organized and the equipment was primitive. Only 10% of a total projected excavation of 26,000 cubic yards had been finished.

- - - - -

Sources of data:

- Mr. E. Geilenberg.
- Dr. Zorn, I.G. Farben, Leuna.

PLANT "DACHS 6"

(a) General Data:

1. Location : Moosbierbaum near St. Poelten/Lower Danube.
2. Construction type : Above ground in woods.
3. Company in charge : Donauchemie.
4. Estimated completion date : - - -
5. Design capacity : See page 152.

(b) Cost and Labor Required:

This project never went beyond the foundation stage.

This was to have been a hidden installation in the woods about 6 km. from the I.G. Refinery at Moosbierbaum. Equipment originally ordered for Moosbierbaum was to be used.

The plant was to consist of the following:

1. Vacuum Distillation.
2. Sulfuric Acid Treating.
3. Hot Clay Contact Plant.
4. Dewaxing.

The projected capacity was 7500 tons per month.

- - - - -

Sources of data:

Mr. E. Geilenberg.

Dr. Zorn - I.G. Farben, Leuna.

PLANT "DACHS 7"

(a) General Data:

1. Location : Alte Poste near Pirna/Saxony.
2. Construction type : Underground
3. Company in charge : Deutsche Gasolin.
4. Estimated completion date : 1 September, 1945
5. Design capacity : See page 152.

(b) Cost and Labor Required:

1. Estimated total cost : 8,000,000 RM.
2. Estimated cost until end of war : 6,000,000 RM.
3. Average number of workmen :

| | |
|--------------|------------|
| a) Skilled | 100 |
| b) Unskilled | 100 |
| c) Foreign | <u>350</u> |
| Total | 550 |
4. Construction labor to end of war : 83,500 man days.
5. Total labor to end of war : 270,000 man days.
6. Total labor for completion of plant : 320,000 man days.

This was to be an underground plant in sandstone tunnels lined with concrete. It was to consist of the following:

| | | |
|------------------------------|---|---------------------------|
| SNF Extraction Plant |) | |
| Meleanu Dewaxing Plant |) | from Dollbergen Refinery. |
| Lube Oil Redistillation Unit |) | |
| Vacuum Distillation Unit |) | new. |
| Hot Clay Contact Plant |) | |

Erection of equipment was just starting.

Sources of data: Mr. E. Geilenberg
Dr. Zorn - I.G. Farben, Leuna.

PLANT "DACRS 8"

Lubricating Oil Plant

(a) General Data:

1. Location : Muehldorf Glatz County, Lower Silesia.
2. Construction type : Open construction above ground.
3. Company in charge : Continental Cel A.G.
4. Estimated completion date : Project abandoned.
5. Design capacity : See page 152.

(b) Cost and Labor Required:

Planning and construction were abandoned before much had been accomplished. This plant was to have been built above ground in a narrow valley.

Equipment was as follows:

- | | | |
|---------------------------|---|---------------------------|
| 1. Distillation |) | |
| 2. Duo-Sol extraction |) | From material ordered for |
| 3. Sulfuric acid treating |) | Trzebinia |
| 4. Hot clay contact |) | |
| 5. Dewaxing |) | Ordered for Iaslo |

The distillation unit had a capacity of 28,000 tons/mo and distillation was accomplished in two passes through the same unit, first at atmospheric pressure and then under vacuum, to achieve the stated plant capacity of 14,000 tons per month of feed.

Sources of data:

Mr. E. Geilenberg

Dr. Zorn - I.G. Farben, Leuna.

DACS

(Underground Lube Oil Plants)

Production in Tons per Month

| <u>DACS</u> | <u>Type of Charge</u> | <u>Feed Rate T/Mo</u> | <u>Gasoline</u> | <u>Diesel & Gas Oil</u> | <u>Machine Oil</u> | <u>Motor Oil</u> | <u>Aviation Oil</u> | <u>Max</u> | <u>Asphalt</u> |
|-------------|-----------------------|-----------------------|-----------------|-----------------------------|--------------------|------------------|---------------------|-------------|----------------|
| 1 | Residuum | 9000 | - | 500 | 3000 | 1950 | 500 | 550 | 2000 |
| 2 | Residuum | 3400 | - | - | 3000 | 2000 | 1800 | 1100 | 2500 |
| 3 | Residuum | 3000 | - | - | 840 | 930 | - | 740 | 450 |
| 4 | Crude Oil | 25000 | 1380 | 7600 | 6635 | 2200 | 1000 | - | 3875 |
| 5* | Kogasin | 7500 | 450 | 2550 | - | 1000 | 2000 | - | - |
| 6 | Residuum | 6000 | - | - | 800 | 2400 | - | 400 | 2060 |
| 7 | Residuum | 6000 | - | 250 | 1900 | 1900 | - | 900 | 1450 |
| 8 | Crude Oil | 14000 | 1500 | 5530 | 4160 | - | 720 | 790 | 720 |
| | | <u>78900</u> | <u>3330</u> | <u>16430</u> | <u>19735</u> | <u>12380</u> | <u>6020</u> | <u>4480</u> | <u>13055</u> |

* This plant was changed from production of synthetic lube oil to cracking only

"STEINBOCK 2"

Paraflow and Catalyst Manufacturing

(a) General Data:

1. Location : Unterloquitz.
2. Construction type : In slate quarry.
3. Company in charge : I. G. Farbenindustrie.
4. Estimated completion date : See following pages.
5. Design capacity : 65 tons per month of Paraflow
85 tons per month of gas phase catalyst
350 tons per month of sump phase catalyst

(b) Cost and Labor Required:

1. Estimated total cost : See following pages.
2. Total labor : See following pages.

(c) Excavation Required:

1. Area : 55,000 sq. ft.
2. Volume : 9,000 cu. yds.

"Steinbock 2" was to be a catalyst manufacturing plant, also a paraflow unit and di-ethyl-benzene (Kybol) plant as originally planned in 1944. In January, 1945, the di-ethyl-benzene (Kybol) plant was dropped and the paraflow unit pushed to offset loss through air raid damage of the only German paraflow plant, in Ludwigshafen.

At the site in Ansbach near Unterloquitz is an old slate mine, originally known as the "Grube Brand". There are five levels, spaced vertically about 90 feet. Slate was being mined in the lowest two levels only. It was planned that the "Gewerkschaft Glueckauf" which operated the slate mine since 1919, was to continue slate mining in the lowest level only.

The top level, which contained the largest existing chambers was to receive the paraflow plant. The other levels were to house the catalyst production. (See perspective drawing on page 160.)

The Organization Todt (OT) was charged with increasing the width and height of the existing tunnels (shown shaded on the perspective drawing), so that the equipment could be moved into the work chambers inside the mountain. The existing tunnels had a cross-section of 6-1/2 x 6-1/2 feet and were being increased to 10 feet wide and 11.5 feet high. The OT was also leveling the floors and installing track. In the parts where equipment was to be installed, the chambers were up to 60 feet high with a minimum protective cover above 115 feet. The "Gewerkschaft Glueckauf" was OT's subcontractor for the tunnel extensions; work was started 15 January 1945 and stopped 8 April 1945.

All levels are interconnected and also connected to the outside. This communication results in a stack effect and the air circulation is very good in the mine. However, a ventilation system (to cost about 50,000 RM) was to be installed.

The I.G. Farben was to install the equipment brought from Poelitz and Ludwigshafen, where the paraflow plant had been bombed beyond repair.

The power plant was to consist of three locomotives. At first, these were to be operated above ground; later these were to be moved inside one of the smaller chambers on the second level.

About 60% of the equipment for the paraflow plant is at the site in or near Unterloquitz but none of it has been actually installed in the mine.

In addition to housing the "Steinbock" installation, large quantities of hydrogenation catalyst from Poelitz and Ueckermuende had been stored in and near the mine.

On the following pages will be found:

1. Table of comparison between the original project, including Kybol (Project I), the reduced project without Kybol (Project II) and Project III with the plant located above ground. (Pages 155-156).
2. A cost estimates as prepared by the I.G. Farben, 16 March 1945. (Pages 157-159).
3. A schematic drawing of the entire und erground mine. (Page 160).

Sources of data:

Mr. W. Wolf, Engineer with the I.G. Farben, Ludwigshafen. Now living near the site in Schaderthal. He was assistant to Mr. Raichle, project manager, appointed by Geilenberg.

STEINBOCK 2

Comparison of the original project of 23 November, 1944, with the project on 3 January, 1945, and an above ground installation:

| Project I dated 23 November, 1944 | Project II dated 3 January 1945 without Kybol | Project III Above ground in- stallation at the "Ludwig" mine without Kybol * |
|---|---|--|
| Production: 65 tons per month paraflow 85 tons per month gas phase catalyst. 350 tons per month sump phase catalyst. 1400 tons per month Kybol. | 65 tons per month paraflow. 85 tons per month gas phase catalyst. 350 tons per month sump phase catalyst. | |
| <u>Material Required:</u> | | |
| New steel for mechanical equipment 2,380 tons | 1,100 tons | 1,100 tons |
| Structural steel, includ- ing rails 1,950 tons | 330 tons (incl. 180 of track) | 40 tons (120 tons) |
| Structural timber 720,000 board feet | 128,000 board feet | 93,300 board feet |
| Cement 1,000 tons | 400 tons | 250 tons (900 tons) |
| Bricks 800,000 pcs. | 100,000 pcs. | 170,000 pcs. |
| Gravel, Sand, Stone 7,000 tons | 5,900 tons | 1,600 tons (6,000 tons) |
| Construction cost 1,800,000 RM | 500,000 RM | 500,000 RM (750,000 RM) |
| <u>Labor Required:</u> | | |
| a) Mining - Skilled .50 | 25 | - - - |
| Unskilled 320 | 160 | - - - |
| b) Construction - Skilled 100 | 95 | 120 |
| Unskilled 750 | 315 | 200 |
| c) Mechanical - Skilled 235 | 110 | 90 |
| Unskilled 415 | 190 | 160 |

* Figures not in parenthesis show "without air raid precautions."
Figures in parenthesis show "with air raid precaution installations."

"STEINBOCK 2" - cont'd

| <u>Going on Stream:</u> | | | |
|--------------------------|------------------|------------------|------------------|
| Catalyst Plant | end of May, 1945 | end of May, 1945 | end of May, 1945 |
| Paraflow | end of Apr, 1945 | end of May, 1945 | end of May, 1945 |
| Kybol | end of Jun, 1945 | - - | - - |
| <u>Time Schedule:</u> | | | |
| Preliminary work at site | - - | | 20 days |
| Planning | - - | | 10 days |
| Mining, excavation | 50 days | | - - |
| Construction work | 75 days | | 105 days |
| Installation | 75 days | | 75 days |

The above tabulation was prepared by the I.G. Farben in January, 1945 to prove that the surface construction is not time-saving, especially as the speed is predicated upon weather conditions and time lost through air raid alarms. The saving of structural steel in Project III is more than offset by the required fragmentation protection walls and air raid shelters as a greater amount of cement is needed. Due to the required air raid precaution measures, the overall total of labor required for the underground installation would not exceed the surface project.

Of course this favorable comparison is possible only due to the fact that an existing mine with sufficiently large underground cavities was selected for this project, and little additional excavation, such as increasing the cross-section of some tunnels was required.

Cost Estimate - "STEINBOCK 2"

Prepared by I.G. Farben, 16 March, 1945

(a) Cost of Mechanical Equipment:
(prices given are for new equipment)

| | |
|---------------------|-------------------|
| Paraflow | 700,000 RM |
| Gas phase catalyst | 1,500,000 RM |
| Sump phase catalyst | 450,000 RM |
| Oppau catalyst | <u>400,000 RM</u> |

Total 3,050,000 RM

Thereof actually new equipment: 1,100,000 RM

(b) Dismantling and Installations:
(could be calculated under air raid damage)

| | |
|--------------|-------------------|
| Dismantling | 300,000 RM |
| Installation | <u>700,000 RM</u> |

Total 1,000,000 RM

(c) Construction Costs:

| | |
|---------------------|------------------|
| Paraflow | 170,000 RM |
| Gas phase catalyst | 300,000 RM |
| Sump phase catalyst | 150,000 RM |
| Oppau catalyst | 140,000 RM |
| Power installations | <u>50,000 RM</u> |

Total 810,000 RM

(d) Mining Costs:

| | |
|--|------------|
| Preparing of the underground rooms and widening and heighthen- ing of existing tunnels | 450,000 RM |
|--|------------|

| | |
|-------------|------------------|
| Ventilation | <u>50,000 RM</u> |
|-------------|------------------|

Total 500,000 RM

(e) Power Installation (mechanical equipment):

| | |
|--------------------|-------------------|
| Boiler plant | 150,000 RM |
| Gas Production | 160,000 RM |
| Power distribution | <u>100,000 RM</u> |

Total 410,000 RM

Cost Estimate - "STEINBOCK 2" - cont'd

(f) Miscellaneous Costs for Installation of the Underground Dispersal Plants:

| | |
|--------------------------------|------------------|
| Railroad | 200,000 RM |
| Fresh water and water disposal | 25,000 RM |
| General lighting | <u>20,000 RM</u> |
| Total | 245,000 RM |

(g) Cost of Preliminary Plannings: 80,000 RM

Breakdown of Cost Between the German Reich and the I.G. Farben

According to current contracts for other projects (DACHS, KUCKUCK, etc.) the Reich carries the following:

| | |
|---|-------------------|
| 1. Mining cost, (d) above | 500,000 RM |
| 2. Miscellaneous costs for installation of the Underground Dispersal plant, (f) above | <u>245,000 RM</u> |
| Total | 745,000 RM |

The complete or partial carrying of the following items by the Reich should be considered:

| | |
|---|---------------------|
| 1. Preliminary planning, (g) above | 80,000 RM |
| 2. Construction cost, (c) above | 810,000 RM |
| 3. Power installation and distribution, (e) above | 410,000 RM |
| 4. Dismantling and installation cost, (b) above | <u>1,000,000 RM</u> |
| Total | 2,300,000 RM |

Through the dispersal underground, the following higher expenditures occur as compared to normal construction above ground:

| | |
|---|-----------|
| 1. Due to longer power lines to plant (access tunnel of about 1000 ft. length) and due to levels being about 100 ft. on center vertically | 75,000 RM |
| 2. Due to longer pipelines for raw and finished products | 50,000 RM |
| 3. Additional cost for necessary elevators due to units being located at various levels | 50,000 RM |

(continued)

Cost Estimate - "STEINBOCK 2" - cont'd

| | |
|--|------------------|
| 4. Additional cost for powerlines (special cables, humidity resistant) | 100,000 RM |
| 5. Additional cost for signal systems for safety precautions and telephone installations | <u>25,000 RM</u> |
| Total | 300,000 RM |

The carrying of this cost by the Reich should be negotiated.

I.G. Farben costs:

Cost of new mechanical equipment 1,100,000 RM

In addition, costs from items (c) and (d) yet to be determined.

Recap:

Without consideration for unforeseen costs, the grand total for the whole project is 4,145,000 RM

Of this, the Reich, in accordance with the directives for the Underground Dispersal Program, carries 745,000 RM

The I.G. Farben will carry 1,100,000 RM

The total or partial taking over of the rest, of 2,300,000 RM by the Reich should be negotiated.

About 6% could be estimated in each case for unforeseen expenditures.

SCHEMATIC VIEW OF UNDERGROUND PLANT STEINBOCK II AT UNTERLOQUITZ, GERMANY

Room 1 - Gas phase catalyst plant (975 ft level)
Air requirements - 812,000 cu. ft./hr.
Ventilation - independent of rest of plant.

Rooms 1, 2, 3 (885) - Kilo catalyst plant
Air requirements - 405,000 cu. ft./hr.
Directly ventilated.

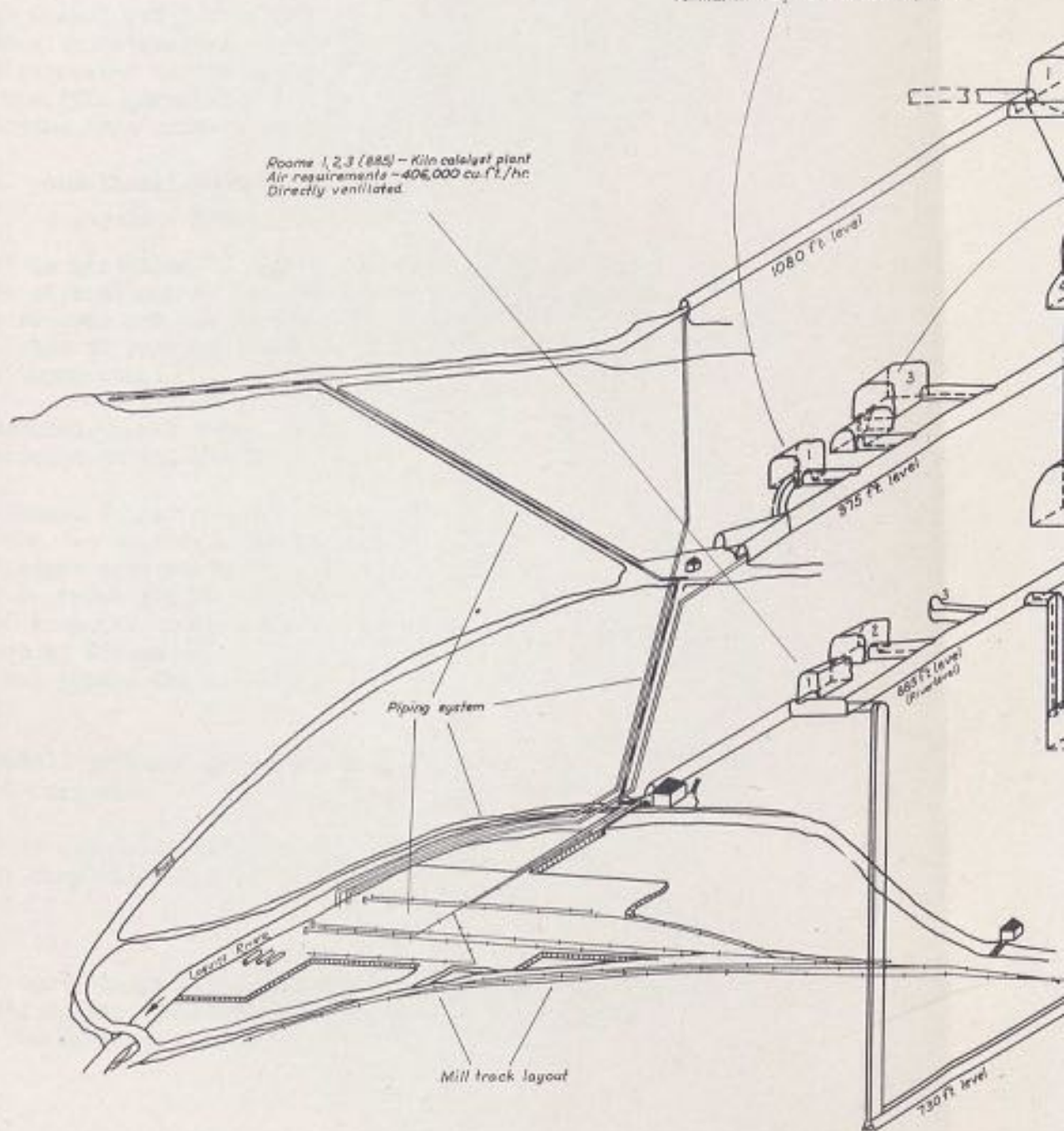

Piping system

Loggia Drive

Mill track layout

1080 ft level

975 ft level

885 ft level
(Rooms 1, 2, 3)

730 ft level

SCHEMATIC VIEW OF UNDERGROUND PLANT STEINBOCK II AT UNTERLOQUITZ, GERMANY

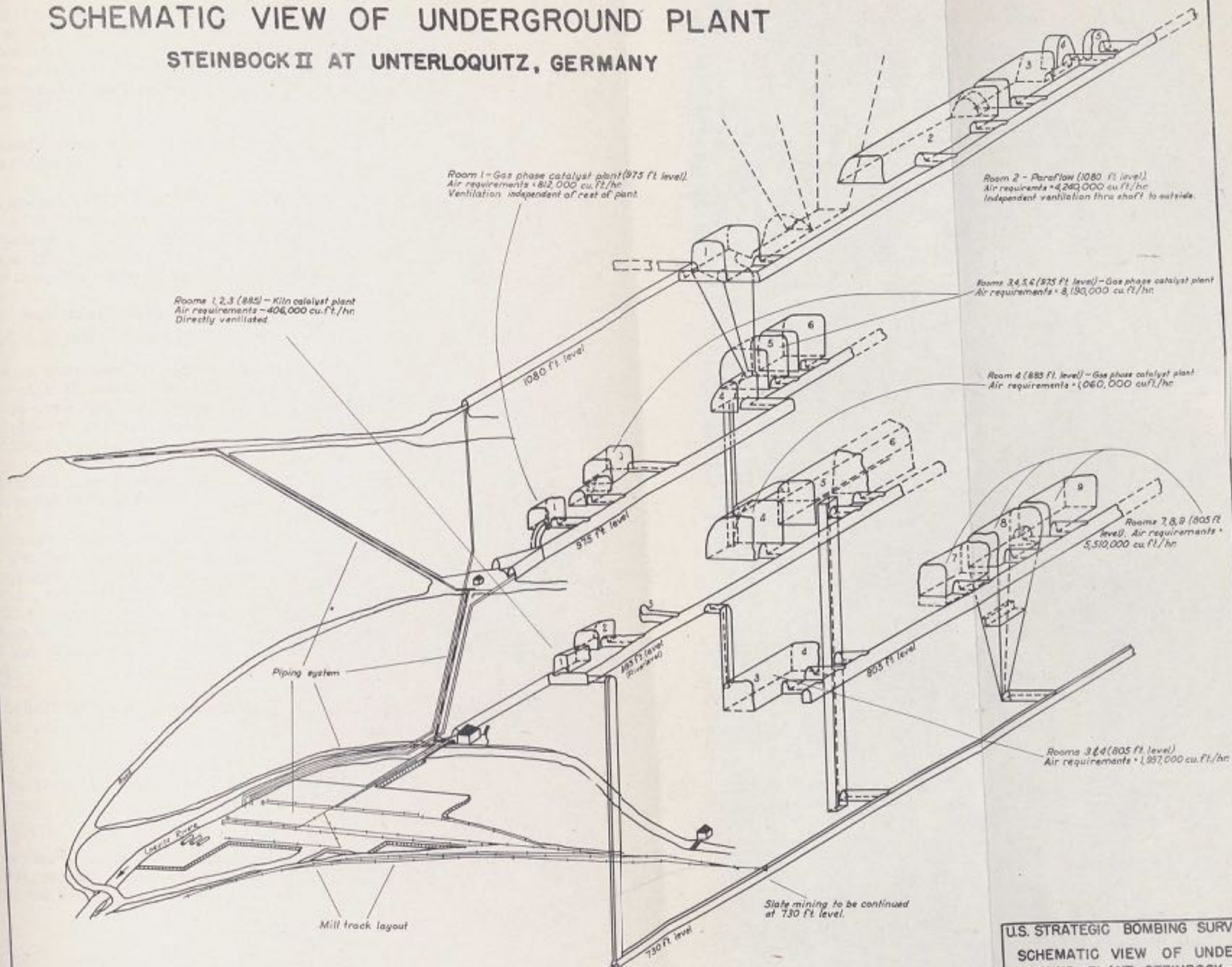

U.S. STRATEGIC BOMBING SURVEY
SCHEMATIC VIEW OF UNDER-
GROUND PLANT STEINBOCK II
AT UNTERLOQUITZ, GERMANY
FIGURE 62

"MOLCH" - OR PHENOL EXTRACTION PLANTS

These plants were designed to remove phenols and cresols from middle oil produced by carbonization of brown coal, thereby producing Diesel oil without hydrogenation and recovering the phenols and cresols normally destroyed by hydrogenation. They were all located close to existing low-temperature carbonization plants so that no increased transportation problems were involved.

Two of these units were to be built by Lurgi and four by Uhde, an I.G. Farben affiliate.

A rough Diesel cut 300 to 660° F. is extracted countercurrently in three stages with metasolvan (a mixture of gasoline and methanol). The phenols are extracted by the methanol and the gasoline serves only to reduce the specific gravity of the oil layer to promote separation. After extraction, the mixture is separated into two layers by settling:

1. A methanol-phenol solution or extract.
2. A gasoline Diesel oil layer.

The oil is distilled to separate Diesel oil and gasoline. This distillation is carried out in two stages--atmospheric and vacuum. The gasoline is re-used and the Diesel oil is re-run to 610° F. EP. Originally, it was hoped to produce Diesel oil without re-running, but this was found to be impractical.

The methanol-phenol solution is distilled for recovery of methanol which is recycled to the extraction system.

The methanol losses are 1/10 to 2/10 per cent of the feed primarily because of the use of available equipment which was too small for the job. With proper equipment, this loss can be reduced to .003%. The six plants were to treat 30,000 tons per month and the methanol loss on this basis was 60 tons per month. Since methanol is only worth 1-1/2 to 2 times as much as Diesel oil, it is not economical to recover the methanol completely and toward the end of the war methanol was apparently no longer critical.

The phenols produced contained about 0.6% sulfur and were not suitable for all purposes.

A list of plants is included on the following pages, giving rates, productions, completion dates and cost information.

Sources of data:

Dr. Herbert, Lurgi Gesellschaft fuer Waermetechnik, mbH, Frankfurt.
Mr. W.L. Ruckes, Construction Engineer for Lurgi.
Mr. E. Geilenberg

"MOLCH 1"

(Phenol Extraction)

(a) General Data:

- | | | |
|------------------------------|---|--|
| 1. Location | : | Obermolwitz near Altenburg/Thuringia. |
| 2. Construction type | : | Open construction above ground. |
| 3. Company in charge | : | DEA. |
| 4. Estimated completion date | : | 25 May, 1945. |
| 5. Design capacity | : | Feed: 9,000 tons per month of middle oil. Production: (in tons per month) Diesel Oil 6,000 Fuel Oil <u>3,000</u> Total 9,000 |

(b) Cost and Labor Required:

- | | | |
|--|---|--|
| 1. Estimated total cost | : | 3,500,000 RM. |
| 2. Estimated cost to end of war | : | 3,000,000 RM. |
| 3. Average number of workmen | : | a) Skilled 100 b) Unskilled 320 c) Foreign <u>100</u> Total 500 |
| 4. Construction labor to end of war | : | 70,000 man days. |
| 5. Total labor to end of war | : | 135,000 man days. |
| 6. Total labor for completion of plant | : | 158,000 man days. |

Note: See general discussion on page 161.

"MOLCH 2"

(Phenol Extraction)

(a) General Data:

1. Location : Hirschfelde, northeast of Zittau.
2. Construction type : Open construction above ground.
3. Company in charge : ASW.
4. Estimated completion date : 30 May, 1945.
5. Design capacity : Feed: 6,700 tons per month of middle oil.
Production: (in tons per month)
Diesel Oil 4,400
Fuel Oil 2,300
Total 6,700

(b) Cost and Labor Required:

1. Estimated total cost : 4,000,000 RM.
2. Estimated cost to end of war : 3,000,000 RM.
3. Average number of workmen : a) Skilled 50
b) Unskilled 150
c) Foreign 250
Total 450
4. Construction labor to end of war : 67,000 man days.
5. Total labor to end of war : 135,000 man days.
6. Total labor to completion of plant : 180,000 man days.

Note: See general discussion on page 161.

"MOLCH 3"

(Phenol Extraction)

(a) General Data:

1. Location : Auschwitz near Gleiwitz/Upper Silesia.
2. Construction type * : Open construction above ground.
3. Company in charge : I.G. Farben
4. Estimated completion date : Finished
5. Design capacity : Feed: 3,200 tons per month of middle oil.
Production: (in tons per month)
Diesel Oil 2,100
Fuel Oil 1,100
Total 3,200

(b) Cost and Labor Required:

1. Estimated total cost : 3,000,000 RM.
2. Estimated cost up end of war : 3,000,000 RM.
3. Average number of workmen : a) Skilled 50
b) Unskilled 150
c) Foreign 200
Total 400
4. Construction labor to end of war : 60,000 man days.
5. Total labor to end of war : 135,000 man days.
6. Total labor to completion : - - -

* This plant was built above ground but was partially destroyed by bombing. Plans were being made to move the plant underground. No progress was made on this because of capture of the area by the Russians.

Note: See general discussion on page 161.

"MOLCH 4"

(Phenol Extraction)

(a) General Data:

1. Location : Miltitz-Reitzschen, south of Meissen.
2. Construction type : Underground in extension of existing tunnel.
3. Company in charge : I.G. Farben.
4. Estimated completion date : 30 June, 1945.
5. Design capacity : Feed: 6,400 tons per month of middle oil.
Production: (in tons per month)
Diesel Oil 3,900
Fuel Oil 2,500

Total 6,400

(b) Cost and Labor Required:

1. Estimated total cost : 4,500,000 RM.
2. Estimated cost to end of war : 2,700,000 RM.
3. Average number of workmen : a) Skilled 150
b) Unskilled 150
c) Foreign 300

Total 600
4. Construction labor to end of war : 90,000 man days.
5. Total labor to end of war : 122,000 man days.
6. Total labor to completion of plant : 202,000 man days.

Note: See general discussion on page 161.

"MOLCH 5"

(Phenol Extraction)

(a) General Data:

- | | | |
|----------------------|---|--|
| 1. Location | : | Niederau, near Dresden. |
| 2. Construction type | : | Open construction above ground. |
| 3. Company in charge | : | Ruestgers. |
| 4. Design capacity | : | Feed: 3,000 tons per month of middle oil. Production: (in tons per month) Diesel Oil 2,000 Fuel Oil <u>1,000</u> Total 3,000 |

(b) Cost and Labor Required:

Records not available. Cost and manpower required similar to other "Molch" plants.

Note 1: This plant differed from the other "Molch" units in that a conventional caustic extraction process was used instead of the gasoline-methanol solvent.

Note 2: See general discussion on page 161.

"MOLCH 6"

(Phenol extraction)

a) General Data:

- | | | |
|------------------------------|---|---|
| 1. Location | : | Nachterstadt. |
| 2. Construction type | : | Open construction above ground. |
| 3. Company in charge | : | Riebeck. |
| 4. Estimated completion date | : | 15 June, 1945. |
| 5. Design capacity | : | Feed: 2,600 tons per month of middle oil. Productions: (in tons per month) Diesel Oil 1,700 Fuel Oil <u>900</u> Total 2,600 |

b) Cost and Labor Required:

- | | | |
|---------------------------------------|---|--|
| 1. Estimated total cost | : | 3,000,000 RM |
| 2. Estimated cost to end of war | : | 2,000,000 RM |
| 3. Average number of workmen | : | a) Skilled 100 b) Unskilled 150 c) Foreign <u>200</u> Total 450 |
| 4. Construction labor to end of war | : | 54,000 man days. |
| 5. Total labor to end of war | : | 90,000 man days. |
| 6. Total labor to completion of plant | : | 135,000 man days. |

Note: See general discussion on page 161.

"WUESTE 1 - 10"

(Shale Oil Plants)

(a) General Data:

1. Location : See next page for individual locations.
2. Construction type : Open construction above ground.
3. Company in charge : Deutsche Oelschiefer-Forschungs-gesellschaft
4. Estimated completion date : Wueste 2, 4, 8, 9 in makeshift production at end of war.

Wueste 1 would have been ready for makeshift production by June 1st.

Wueste 3, 5, 6, 7 and 10 were postponed. Required construction time 2 to 3 months.
5. Design capacity : Feed: 45,000 tons of oil shale (each plant)
1250 to 1800 tons of shale oil

(b) Cost and Labor Required for 10 Plants:

1. Estimated total cost : 48,000,000 RM.
2. Estimated cost to end of war : 36,000,000 RM.
3. Average number of employees : a) Skilled 500
b) Unskilled 750
c) Foreign 3,750

Total 5,000
4. Construction labor to end of war : 1,060,000 man days.
5. Total labor to end of war : 1,650,000 man days.
6. Total labor to complete plant : 2,160,000 man days.

1. Nehren
2. Wessingen
3. Engstlatt
4. Erzingen North
5. Erzingen West
6. Dormettingen West
7. Dormettingen Center
8. Dormettingen South
9. Schoemberg
10. Zepfenhan

The following five additional plants were contemplated but were dropped later:

11. Schaerzingen
12. Schandelah (Brunswick)
13. Schoemberg
14. Dotternhausen
15. Frommern

Construction by the D.B.H.G. (Deutsche Bergwerks- und Huetttenbau G.m.b.H.)

Baron H.J. Kruedener, who for years was interested in oil production from shale was charged with planning and constructing shale oil plants in 1943 by the Chief of the Armament Supply Division of the Army, (Ruestungsplan, but in 1944 after partial destruction of hydrogenation plants, the Commissioner General for the Chemical Industry supported this project and ordered construction of 10 plants by the Commissioner General for Immediate Measures, Gaildorf.

Construction began in July 1944. Four makeshift plants went on stream in March 1945, with a daily production of about 25 tons each.

In moving kilns 10-feet high, oil is distilled from shale at medium temperatures, the oil shale supplying most of the required heat through partial burning. "Kiln" in this case simply means a heaped pile of shale, the surface of which was covered with a layer of peat. This layer was used to ignite the kiln, as well as to protect the burning during rains. Oil is formed by cracking at 900° - 1600° F. The oil vapors are sucked away through probes sunk into the kiln and discharged through a jet condenser and an electric filter into the combustion furnace where non-condensable gases are burned. The kiln must operate at 1400° - 1650° F.

The burned shale remains in place to be covered with the original earth layer.

The minimum distance between the moving kiln and the edge of the shale deposit should be 600 to 900 feet. Surface deposits of 6 feet minimum thickness, amounting to at least 2,000,000 tons of shale were considered necessary to justify installation of a plant. The oil content on the average is about 4.5% according to Fischer. The crushing of shale to walnut size was desirable and experiments were started to determine explosives and drilling arrangements in order to obtain such shapes.

Strip mining alongside railway track was planned. To move one ton of shale costs about 2 RM where overburden is not more than 2 - 7 feet (open cut method). If overburden is thick and mining through shafts and tunnels is necessary, the cost per ton of shale would increase to 6 - 7 RM.

In order to utilize the German oil shale deposits in Wuerttemberg, 10 simple low-temperature distillation plants were planned with a total capacity of about 18,000 tons per month of shale oil. This oil can be used without further processing as fuel for hot bulb motors (Lanz Motors). It could not be used in jet propulsion for the ME262 because it cokes.

There were 50,000 motors used in agricultural machines, 10,000 motors used in industry and 10,000 motors used by the Army, or a total of 70,000 motors. According to Lanz, an average of 5 tons of fuel is consumed per motor per year. The yearly consumption therefore is:

$$70,000 \times 5 = 350,000 \text{ tons.}$$

Estimated production in the 10 Wueste plants:

$$1800 \times 10 \times 12 = 216,000 \text{ tons per year.}$$

Total steel required for the 10 plants is 17,000 tons (10,000 tons thereof for machines and equipment).

All Wueste plants are above ground in open locations which are camouflaged to a great extent.

Throughput per plant per month - 45,000 tons of oil shale.

Production per plant per month was estimated to be 1250 to 1800 tons of shale oil.

75,000 to 85,000 gallons of water per 24 hours was estimated necessary for a plant with 1500 tons per day of oil production (excluding gasoline production - if gasoline was to be produced, the water requirements would be doubled).

Total powder requirements for the 10 plants was estimated at 1250 tons per year. During three weeks of operation, four "Wueste" plants yielded 30 - 35% of the oil present in the shale. The pilot plant yield was 50 - 60%. In the Dr. Graf oven (simplest and most modern solution), recovery was about 85 - 95%.

The shale oil cannot be compared with regular mineral oil due to the process of direct burning. The oil is very sensitive to heat and light, and is not stable in storage. It can be used successfully in hydrogenation where its high sulfur content is advantageous (4% sulfur in oil). However, this use cannot be justified commercially.

- - - - -

Sources of data:

Baron Von Kruedener, of Speer Ministry.

Mr. E. Geilenberg.

"KREBS 1 - 2"

(Fischer-Tropsch Plant)

I. KREBS 1:

1. Location : Ambrock near Hagen.
2. Construction type : Underground.
3. Company in charge : Ruhr Chemie.

It had been planned to place 20 Fischer ovens in tunnels dug into the face of the cliff. As the plans were changed to include fewer than 20 ovens, the surplus tunnel space was given over to the Continental Rubber Company of Hannover for rubber storage purposes. This was a small plant as the average Fischer plant uses 100 to 150 ovens. Based on the number of ovens, the capacity would be about 1000 tons per month.

II. KREBS 2:

This plant never progressed beyond the planning stage.

- - - - -

Sources of data:

Mr. E. Geilenberg.

Files of Prof. Krauch, Commissioner General for

Problems of the Chemical Industry.

"FRITZ"

(Dewaxing Plant)

(a) General Data:

1. Location : Neuland on the Neisse.
2. Estimated completion date : Believed to have been completed.
3. Estimated capacity : 1000 - 2000 tons per month.

This was a makeshift dewaxing plant that had been moved from the Erdoelwerke Idaweihe, Kattowitz into the basement of a brewery. The cooling plant of the brewery was to be utilized to supplement the refrigeration equipment of the plant.

- - - - -

Sources of data:

Dr. Kranepuhl, I.G. Farben, Leuna.

"STEINBOCK 1"

I. GENERAL: A complete program for the use of the tunnels of the salt mine at Heilbronn for housing several different chemical installations had been postulated. The program called for building a factory for the production of Hydrazin-Hydrate, V-2 weapon fuel (code name: B material); the production of 85% Hydrogen Peroxide (code name: T material); the production of various base materials for the manufacture of propellants and high explosives, such as diglycol; the production of tetraethyl lead; a plant for the repair of high pressure valves and fittings for hydrogenation units; and the storage of catalyst for the production of ammonia and methanol.

II. Of all this program, only the plant for high pressure equipment maintenance and the catalyst storage area were actually carried beyond the planning stage. The following applies only to the part put into effect:

(a) General Data:

- | | | |
|------------------------------|---|---------------------------|
| 1. Location | : | Heilbronn. |
| 2. Construction type | : | Underground in salt mine. |
| 3. Company in charge | : | I.G. Farben. |
| 4. Estimated completion date | : | 1 June, 1945. |

(b) Cost and Labor required:

- | | | |
|-------------------------------------|---|--|
| 1. Estimated total cost | : | 1,000,000 RM. |
| 2. Estimated cost to end of war | : | 300,000 RM. |
| 3. Average number of workmen | : | a) Skilled 100 b) Unskilled 10 c) Foreign <u>100</u> Total 210 |
| 4. Construction labor to end of war | : | 12,000 man days. |

5. Total labor to
end of war : 13,000 man days.

6. Total labor to com-
pletion of plant : 45,000 man days.

(c) Excavation required:

1. Area : 100,000 sq. ft.

2. Volume : 90,000 cu. yds.

- - - - -

Sources of data:

Mr. E. Geilenberg.

Files of Prof. Krauch, Commissioner General for

Problems of the Chemical Industry.

"RABE"

(Tetraethyl Lead Plant)

(a) General Data:

1. Location : Brixlegg, Austrian Tyrol.
2. Construction type : In natural cave, about large enough to accommodate a commercial plant of conventional design and construction.
3. Company in charge : Baryt, G.m.b.H. a joint subsidiary of I.G. Farben and Lauranil of Innsbruck.
4. Estimated date of completion : 1 March, 1945.
5. Constructed by : Organization Todt.
6. Excavation required : Area: 107,000 sq. ft.;
Volume: 29,000 cu. yds.
This included squaring off the somewhat egg-shaped cave, and boring two tunnels.
7. Capacity : 200 tons/month tetraethyl lead

The RABE (tetraethyl lead plant) is the only one reported which was to be constructed in a natural cave. This was a particularly judicious choice, as this provided readily the high vertical clearance (120 feet) preferred for this type of operation.

The plan was considered entirely impractical by the manager of the Frose tetraethyl lead plant. The construction work never kept up with schedule, and at the time of surrender, two months after the originally planned completion date, the equipment was only beginning to reach the site, and none of it had been erected.

UNITED STATES STRATEGIC BOMBING SURVEY

LIST OF REPORTS

The following is a bibliography of reports resulting from the Survey's studies of the European and Pacific wars. Those reports marked with an asterisk (*) may be purchased from the Superintendent of Documents at the Government Printing Office, Washington, D. C.

European War

OFFICE OF THE CHAIRMAN

- *1 The United States Strategic Bombing Survey: Summary Report (European War)
- *2 The United States Strategic Bombing Survey: Overall Report (European War)
- *3 The Effects of Strategic Bombing on the German War Economy

AIRCRAFT DIVISION

(By Division and Branch)

- *4 Aircraft Division Industry Report
- 5 Inspection Visits to Various Targets (Special Report)

Airframes Branch

- 6 Junkers Aircraft and Aero Engine Works, Dessau, Germany
- 7 Erla Maschinenwerke G m b H, Heiterblick, German
- 8 A T G Maschinenbau, G m b H, Leipzig (Mockau), Germany
- 9 Gothaer Waggonfabrik, A G, Gotha, Germany
- 10 Focke Wulf Aircraft Plant, Bremen, Germany
- 11 Messerschmitt A G, Augsburg, Germany

| | |
|---|-----------------------|
| { | Over-all Report |
| | Part A |
| | Part B |
| | Appendices I, II, III |
- 12 Dornier Works, Friedrichshafen & Munich, Germany
- 13 Gerhard Fieseler Werke G m b H, Kassel, Germany
- 14 Wiener Neustaedter Flugzeugwerke, Wiener Neustadt, Austria

Aero Engines Branch

- 15 Bussing NAG Flugmotorenwerke G m b H, Brunswick, Germany
- 16 Mittel-Deutsche Motorenwerke G m b H, Taucha, Germany
- 17 Bavarian Motor Works Inc, Eisenach & Durrerhof, Germany
- 18 Bayerische Motorenwerke A G (BMW) Munich, Germany
- 19 Henschel Flugmotorenwerke, Kassel, Germany

Light Metal Branch

- 20 Light Metals Industry

| | |
|---|-----------------------------|
| { | Part I, Aluminum of Germany |
| | Part II, Magnesium |

- 21 Vereinigte Deutsche Metallwerke, Hildesheim, Germany
- 22 Metallgussgesellschaft G m b H, Leipzig, Germany
- 23 Aluminiumwerk G m b H, Plant No. 2, Bitterfeld, Germany
- 24 Gebrueder Giulini G m b H, Ludwigshafen, Germany
- 25 Luftschiffbau, Zeppelin G m b H, Friedrichshafen on Bodensee, Germany
- 26 Wieland Werke A G, Ulm, Germany
- 27 Rudolph Rautenbach Leichtmetallgiessereien, Solingen, Germany
- 28 Lippewerke Vereinigte Aluminiumwerke A G, Lunen, Germany
- 29 Vereinigte Deutsche Metallwerke, Hedderheim, Germany
- 30 Duereiner Metallwerke A G, Duren Wittenau-Berlin & Waren, Germany

AREA STUDIES DIVISION

- *31 Area Studies Division Report
- 32 A Detailed Study of the Effects of Area Bombing on Hamburg
- 33 A Detailed Study of the Effects of Area Bombing on Wuppertal
- 34 A Detailed Study of the Effects of Area Bombing on Dusseldorf
- 35 A Detailed Study of the Effects of Area Bombing on Solingen
- 36 A Detailed Study of the Effects of Area Bombing on Remscheid
- 37 A Detailed Study of the Effects of Area Bombing on Darmstadt
- 38 A Detailed Study of the Effects of Area Bombing on Lubeck
- 39 A Brief Study of the Effects of Area Bombing on Berlin, Augsburg, Bochum, Leipzig, Hagen, Dortmund, Oberhausen, Schweinfurt, and Bremen

CIVILIAN DEFENSE DIVISION

- *40 Civilian Defense Division—Final Report
- 41 Cologne Field Report
- 42 Bonn Field Report
- 43 Hanover Field Report
- 44 Hamburg Field Report—Vol I, Text; Vol II, Exhibits
- 45 Bad Odesloe Field Report
- 46 Augsburg Field Report
- 47 Reception Areas in Bavaria, Germany

EQUIPMENT DIVISION

Electrical Branch

- *48 German Electrical Equipment Industry Report
- 49 Brown Boveri et Cie, Mannheim Kafertal, Germany

Optical and Precision Instrument Branch

- *50 Optical and Precision Instrument Industry Report

Abrasives Branch

- *51 The German Abrasive Industry
- 52 Mayer and Schmidt, Offenbach on Main, Germany

Anti-Friction Branch

- *53 The German Anti-Friction Bearings Industry

Machine Tools Branch

- *54 Machine Tools & Machinery as Capital Equipment
- *55 Machine Tool Industry in Germany
- 56 Herman Kolb Co., Cologne, Germany
- 57 Collet and Engelhard, Offenbach, Germany
- 58 Naxos Union, Frankfurt on Main, Germany

MILITARY ANALYSIS DIVISION

- 59 The Defeat of the German Air Force
- 60 V-Weapons (Crossbow) Campaign
- 61 Air Force Rate of Operation
- 62 Weather Factors in Combat Bombardment Operations in the European Theatre
- 63 Bombing Accuracy, USAAF Heavy and Medium Bombers in the ETO
- 64 Description of RAF Bombing
- 64a The Impact of the Allied Air Effort on German Logistics

MORALE DIVISION

- *64b The Effects of Strategic Bombing on German Morale (Vol I and Vol II)

Medical Branch

- *65 The Effect of Bombing on Health and Medical Care in Germany

MUNITIONS DIVISION

Heavy Industry Branch

- *66 The Coking Industry Report on Germany
- 67 Coking Plant Report No. 1, Sections A, B, C, & D
- 68 Gutehoffnungshuette, Oberhausen, Germany
- 69 Friedrich-Alfred Huette, Rheinhausen, Germany
- 70 Neunkirchen Eisenwerke A G, Neunkirchen, Germany
- 71 Reichswerke Hermann Goering A G, Hallendorf, Germany
- 72 August Thyssen Huette A G, Hamborn, Germany
- 73 Friedrich Krupp A G, Borbeck Plant, Essen, Germany
- 74 Dortmund Hoerder Huetteverein, A G, Dortmund, Germany
- 75 Hoesch A G, Dortmund, Germany
- 76 Bochumer Verein fuer Gusstahlfabrikation A G, Bochum, Germany

Motor Vehicles and Tanks Branch

- *77 German Motor Vehicles Industry Report
- *78 Tank Industry Report
- 79 Daimler Benz A G, Unterturkheim, Germany
- 80 Renault Motor Vehicles Plant, Billancourt, Paris
- 81 Adam Opel, Russelheim, Germany
- 82 Daimler Benz-Gaggenau Works, Gaggenau, Germany
- 83 Maschinenfabrik Augsburg-Nurnberg, Nurnberg, Germany
- 84 Auto Union A G, Chemnitz and Zwickau, Germany
- 85 Henschel & Sohn, Kassel, Germany
- 86 Maybach Motor Works, Friedrichshafen, Germany
- 87 Voigtlander, Maschinenfabrik A G, Plauen, Germany
- 88 Volkswagenwerke, Fallersleben, Germany
- 89 Bussing NAG, Brunswick, Germany
- 90 Muehlenbau Industrie A G (Ming) Brunswick, Germany
- 91 Friedrich Krupp Grusonwerke, Magdeburg, Germany

Submarine Branch

- 92 German Submarine Industry Report
- 93 Maschinenfabrik Augsburg-Nurnberg A G, Augsburg, Germany
- 94 Blohm and Voss Shipyards, Hamburg, Germany
- 95 Deutsche Werke A. G., Kiel, Germany
- 96 Deutsche Schiff und Maschinenbau, Bremen, Germany
- 97 Friedrich Krupp Germaniawerft, Kiel, Germany
- 98 Howaldtswerke A. G., Hamburg, Germany
- 99 Submarine Assembly Shelter, Farge, Germany
- 100 Bremer Vulkan, Vegesack, Germany

Ordnance Branch

- *101 Ordnance Industry Report
- 102 Friedrich Krupp Grusonwerke A. G. Magdeburg, Germany
- 103 Bochumer Verein fuer Gusstahlfabrikation A G, Bochum, Germany
- 104 Henschel & Sohn, Kassel, Germany
- 105 Rheinmetall-Borsig, Dusseldorf, Germany
- 106 Hermann Goering Werke, Braunschweig, Hallendorf, Germany
- 107 Hannoverische Maschinenbau, Hanover, Germany
- 108 Gusstahlfabrik Friedrich Krupp, Essen, Germany

OIL DIVISION

- *109 Oil Division, Final Report
- *110 Oil Division, Final Report, Appendix
- *111 Powder, Explosives, Special Rockets and Jet Propellants, War Gases and Smoke Acid (Ministerial Report #1)
- 112 Underground and Dispersal Plants in Greater Germany
- 113 The German Oil Industry, Ministerial Report Team 78
- 114 Ministerial Report on Chemicals

Oil Branch

- 115 Ammoniakwerke Merseburg G m b H, Leuna, Germany—2 Appendices
- 116 Braunkohle Benzin A G, Zeitz and Bohlen, Germany Wintershall A G, Leutzendorf, Germany
- 117 Ludwigshafen-Opau Works of I G Farbenindustrie A G, Ludwigshafen, Germany
- 118 Ruhroel Hydrogenation Plant, Bottrop-Boy, Germany, Vol. I, Vol. II
- 119 Rhenania Ossag Mineraloelwerke A G, Harburg Refinery, Hamburg, Germany
- 120 Rhenania Ossag Mineraloelwerke A G, Grasbrook Refinery, Hamburg, Germany
- 121 Rhenania Ossag Mineraloelwerke A G, Wilhelmsburg Refinery, Hamburg, Germany
- 122 Gewerkschaft Victor, Castrop-Iauxel, Germany, Vol. I & Vol. II
- 123 Europaeische Tanklager und Transport A G, Hamburg, Germany
- 124 Ebano Asphalt Werke A G, Harburg Refinery, Hamburg, Germany
- 125 Meerbeck Rheinpreussen Synthetic Oil Plant—Vol. I & Vol. II

Rubber Branch

- 126 Deutsche Dunlop Gummi Co., Hanau on Main, Germany
- 127 Continental Gummiwerke, Hanover, Germany
- 128 Huels Synthetic Rubber Plant
- 129 Ministerial Report on German Rubber Industry

Propellants Branch

- 130 Elektrochemischewerke, Munich, Germany
- 131 Schoenebeck Explosive Plant, Lignose Sprengstoff Werke G m b H, Bad Salzemen, Germany
- 132 Plants of Dynamit A G, Vormal, Alfred Nobel & Co, Troisdorf, Clausthal, Drummel and Duneberg, Germany
- 133 Deutsche Sprengchemie G m b H, Kraiburg, Germany

OVER-ALL ECONOMIC EFFECTS DIVISION

- 134 Over-all Economic Effects Division Report
- Gross National Product.....
- Kriegsbeilberichte.....
- Herman Goering Works.....
- Food and Agriculture.....
- 134a Industrial Sales Output and Productivity

Special papers which together comprise the above report

PHYSICAL DAMAGE DIVISION

- 134b Physical Damage Division Report (ETO)
- 135 Villacoublay Airdrome, Paris, France
- 136 Railroad Repair Yards, Malines, Belgium
- 137 Railroad Repair Yards, Louvain, Belgium
- 138 Railroad Repair Yards, Hasselt, Belgium
- 139 Railroad Repair Yards, Namur, Belgium
- 140 Submarine Pens, Brest, France
- 141 Powder Plant, Angouleme, France
- 142 Powder Plant, Bergerae, France
- 143 Coking Plants, Montigny & Liege, Belgium
- 144 Fort St. Blaise Verdun Group, Metz, France
- 145 Gnome et Rhone, Limoges, France
- 146 Michelin Tire Factory, Clermont-Ferrand, France
- 147 Gnome et Rhone Aero Engine Factory, Le Mans, France
- 148 Kugelfischer Bearing Ball Plant, Ebelsbach, Germany
- 149 Louis Breguet Aircraft Plant, Toulouse, France
- 150 S. N. C. A. S. E. Aircraft Plant, Toulouse, France
- 151 A. I. A. Aircraft Plant, Toulouse, France
- 152 V Weapons in London
- 153 City Area of Krefeld
- 154 Public Air Raid Shelters in Germany
- 155 Goldenberg Thermal Electric Power Station, Knap-sack, Germany
- 156 Brauweiler Transformer & Switching Station, Brau-weiler, Germany
- 157 Storage Depot, Nahbollenbach, Germany
- 158 Railway and Road Bridge, Bad Munster, Germany
- 159 Railway Bridge, Eller, Germany
- 160 Gustloff-Werke Weimar, Weimar, Germany
- 161 Henschel & Sohn G m b H, Kassel, Germany
- 162 Area Survey at Pirmasens, Germany
- 163 Hanomag, Hanover, Germany
- 164 M A N Werke Augsburg, Augsburg, Germany
- 165 Friedrich Krupp A G, Essen, Germany
- 166 Erla Maschinenwerke G m b H, Heiterblick, Ger-many
- 167 A T G Maschinenbau G m b H, Mockau, Germany
- 168 Erla Maschinenwerke G m b H, Mockau, Germany
- 169 Bayerische Motorenwerke, Durrerhof, Germany
- 170 Mittel-Deutsche Motorenwerke G m b H, Taucha, Germany
- 171 Submarine Pens Deutsche-Werft, Hamburg, Germany
- 172 Multi-Storied Structures, Hamburg, Germany
- 173 Continental Gummiwerke, Hanover, Germany
- 174 Kassel Marshalling Yards, Kassel, Germany
- 175 Ammonia Werke, Merseburg-Leuna, Germany
- 176 Brown Boveri et Cie, Mannheim, Kafertal, Germany
- 177 Adam Opel A G, Russelsheim, Germany
- 178 Daimler-Benz A G, Unterturkheim, Germany
- 179 Valentin Submarine Assembly, Farge, Germany
- 180 Volkswaggonwerke, Fallersleben, Germany
- 181 Railway Viaduct at Bielefeld, Germany
- 182 Ship Yards Howaldtswerke, Hamburg, Germany
- 183 Blohm and Voss Shipyards, Hamburg, Germany

- 184 Daimler-Benz A G, Mannheim, Germany
- 185 Synthetic Oil Plant, Meerbeck-Hamburg, Germany
- 186 Gewerkschaft Vietor, Castrop-Rauxel, Germany
- 187 Klockner Humboldt Deutz, Ulm, Germany
- 188 Ruhroel Hydrogenation Plant, Bottrop-Boy, Germany
- 189 Neunkirchen Eisenwerke A G, Neunkirchen, Germany
- 190 Railway Viaduct at Altenbecken, Germany
- 191 Railway Viaduct at Arnsburg, Germany
- 192 Deurag-Nerag Refineries, Misburg, Germany
- 193 Fire Raids on German Cities
- 194 I G Farbenindustrie, Ludwigshafen, Germany, Vol I & Vol II
- 195 Roundhouse in Marshalling Yard, Ulm, Germany
- 196 I G Farbenindustrie, Leverkusen, Germany
- 197 Chemische-Werke, Huels, Germany
- 198 Gremberg Marshalling Yard, Gremberg, Germany
- 199 Locomotive Shops and Bridges at Hamm, Germany

TRANSPORTATION DIVISION

- *200 The Effects of Strategic Bombing on German Trans-
portation
- 201 Rail Operations Over the Brenner Pass
- 202 Effects of Bombing on Railroad Installations in
Regensburg, Nurnberg and Munich Divisions
- 203 German Locomotive Industry During the War
- 204 German Military Railroad Traffic

UTILITIES DIVISION

- *205 German Electric Utilities Industry Report
- 206 1 to 10 in Vol I "Utilities Division Plant Reports"
- 207 11 to 20 in Vol II "Utilities Division Plant Reports"
- 208 21 Rheinische-Westfalische Elektrizitaetswerk A G

Pacific War

OFFICE OF THE CHAIRMAN

- *1 Summary Report (Pacific War)
- *2 Japan's Struggle to End The War
- *3 The Effects of Atomic Bombs on Hiroshima and
Nagasaki

CIVILIAN STUDIES

Civilian Defense Division

- 4 Field Report Covering Air Raid Protection and Allied
Subjects, Tokyo, Japan
- 5 Field Report Covering Air Raid Protection and Allied
Subjects, Nagasaki, Japan
- *6 Field Report Covering Air Raid Protection and Allied
Subjects, Kyoto, Japan
- 7 Field Report Covering Air Raid Protection and Allied
Subjects, Kobe, Japan
- 8 Field Report Covering Air Raid Protection and Allied
Subjects, Osaka, Japan
- 9 Field Report Covering Air Raid Protection and Allied
Subjects, Hiroshima, Japan—No. 1
- *10 Summary Report Covering Air Raid Protection and
Allied Subjects in Japan
- *11 Final Report Covering Air Raid Protection and
Allied Subjects in Japan

Medical Division

- *12 The Effects of Bombing on Health and Medical Ser-
vices in Japan
- *13 The Effects of Atomic Bombs on Health and Medical
Services in Hiroshima and Nagasaki

Morale Division

- *14 The Effects of Strategic Bombing on Japanese Morale

ECONOMIC STUDIES

Aircraft Division

- *15 The Japanese Aircraft Industry
- *16 Mitsubishi Heavy Industries, Ltd.
Corporation Report No. I
(Mitsubishi Jukogyo KK)
(Airframes & Engines)
- *17 Nakajima Aircraft Company, Ltd.
Corporation Report No. II
(Nakajima Hikoki KK)
(Airframes & Engines)
- *18 Kawanishi Aircraft Company
Corporation Report No. III
(Kawanishi Kokuki Kabushiki Kaisha)
(Airframes)
- *19 Kawasaki Aircraft Industries Company, Inc.
Corporation Report No. IV
(Kawasaki Kokuki Kogyo Kabushiki Kaisha)
(Airframes & Engines)
- *20 Aichi Aircraft Company
Corporation Report No. V
(Aichi Kokuki KK)
(Airframes & Engines)
- *21 Sumitomo Metal Industries, Propeller Division
Corporation Report No. VI
(Sumitomo Kinzoku Kogyo KK, Puropera Seizosho)
(Propellers)
- *22 Hitachi Aircraft Company
Corporation Report No. VII
(Hitachi Kokuki KK)
(Airframes & Engines)
- *23 Japan International Air Industries, Ltd.
Corporation Report No. VIII
(Nippon Kokusai Koku Kogyo KK)
(Airframes)
- *24 Japan Musical Instrument Manufacturing Company
Corporation Report No. IX
(Nippon Gakki Seizo KK)
(Propellers)
- *25 Tachikawa Aircraft Company
Corporation Report No. X
(Tachikawa Hikoki KK)
(Airframes)
- *26 Fuji Airplane Company
Corporation Report No. XI
(Fuji Hikoki KK)
(Airframes)
- *27 Showa Airplane Company
Corporation Report No. XII
(Showa Hikoki Kogyo KK)
(Airframes)
- *28 Ishikawajima Aircraft Industries Company, Ltd.
Corporation Report No. XIII
(Ishikawajima Koku Kogyo Kabushiki Kaisha)
(Engines)
- *29 Nippon Airplane Company
Corporation Report No. XIV
(Nippon Hikoki KK)
(Airframes)
- *30 Kyushu Airplane Company
Corporation Report No. XV
(Kyushu Hikoki KK)
(Airframes)
- *31 Shoda Engineering Company
Corporation Report No. XVI
(Shoda Selsakujo)
(Components)
- *32 Mitaka Aircraft Industries
Corporation Report No. XVII
(Mitaka Koku Kogyo Kabushiki Kaisha)
(Components)

- *33 Nissan Automobile Company
Corporation Report No. XVIII
(Nissan Jidosha KK)
(Engines)
- *34 Army Air Arsenal & Navy Air Depots
Corporation Report No. XIX
(Airframes and Engines)
- *35 Underground Production of Japanese Aircraft
Report No. XX

Basic Materials Division

- *36 Coal and Metals in Japan's War Economy

Capital Goods, Equipment and Construction Division

- *37 The Japanese Construction Industry
- *38 Japanese Electrical Equipment
- *39 The Japanese Machine Building Industry

Electric Power Division

- *40 The Electric Power Industry of Japan
- *41 The Electric Power Industry of Japan (Plant Reports)

Manpower, Food and Civilian Supplies Division

- *42 The Japanese Wartime Standard of Living and Utilization of Manpower

Military Supplies Division

- *43 Japanese War Production Industries
- *44 Japanese Naval Ordnance
- 45 Japanese Army Ordnance
- *46 Japanese Naval Shipbuilding
- *47 Japanese Motor Vehicle Industry
- *48 Japanese Merchant Shipbuilding

Oil and Chemical Division

- 49 Chemicals in Japan's War
- 50 Chemicals in Japan's War—Appendix
- 51 Oil in Japan's War
- 52 Oil in Japan's War—Appendix

Over-all Economic Effects Division

- *53 The Effects of Strategic Bombing on Japan's War Economy (Including Appendix A: U. S. Economic Intelligence on Japan—Analysis and Comparison; Appendix B: Gross National Product on Japan and Its Components; Appendix C: Statistical Sources).

Transportation Division

- *54 The War Against Japanese Transportation, 1941-1945

Urban Areas Division

- *55 Effects of Air Attack on Japanese Urban Economy (Summary Report)
- *56 Effects of Air Attack on Urban Complex Tokyo-Kawasaki-Yokohama
- *57 Effects of Air Attack on the City of Nagoya
- *58 Effects of Air Attack on Osaka-Kobe-Kyoto
- 59 Effects of Air Attack on the City of Nagasaki
- 60 Effects of Air Attack on the City of Hiroshima

MILITARY STUDIES

Military Analysis Division

- 61 Air Forces Allied with the United States in the War Against Japan
- 62 Japanese Air Power
- 63 Japanese Air Weapons and Tactics
- 64 The Effect of Air Action on Japanese Ground Army Logistics
- 65 Employment of Forces Under the Southwest Pacific Command
- 66 The Strategic Air Operations of Very Heavy Bombardment in the War Against Japan (Twentieth Air Force)
- 67 Air Operations in China, Burma, India—World War II
- 68 The Air Transport Command in the War Against Japan
- 69 The Thirteenth Air Force in the War Against Japan
- 70 The Seventh and Eleventh Air Forces in the War Against Japan
- 71 The Fifth Air Force in the War Against Japan

Naval Analysis Division

- *72 The Interrogations of Japanese Officials (Vols. I and II)
- *73 Campaigns of the Pacific War
- *74 The Reduction of Wake Island
- *75 The Allied Campaign Against Rabaul
- 76 The American Campaign Against Wotje, Maloelap, Mille, and Jaluit (Vols. I, II and III)
- *77 The Reduction of Truk
- 78 The Offensive Mine Laying Campaign Against Japan
- 79 Report of Ships Bombardment Survey Party—Foreword, Introduction, Conclusions, and General Summary
- 80 Report of Ships Bombardment Survey Party (Enclosure A), Kamaishi Area
- 81 Report of Ships Bombardment Survey Party (Enclosure B), Hamamatsu Area
- 82 Report of Ships Bombardment Survey Party (Enclosure C), Hitachi Area
- 83 Report of Ships Bombardment Survey Party (Enclosure D), Hakodate Area
- 84 Report of Ships Bombardment Survey Party (Enclosure E), Muroran Area
- 85 Report of Ships Bombardment Survey Party (Enclosure F), Shimizu Area
- 86 Report of Ships Bombardment Survey Party (Enclosures G and H), Shionomi-Saki and Nojima-Saki Areas

- 87 Report of Ships Bombardment Survey Party (Enclosure I), Comments and Data on Effectiveness of Ammunition
- 88 Report of Ships Bombardment Survey Party (Enclosure J), Comments and Data on Accuracy of Firing
- 89 Reports of Ships Bombardment Survey Party (Enclosure K), Effects of Surface Bombardments on Japanese War Potential

Physical Damage Division

- 90 Effect of the Incendiary Bomb Attacks on Japan (a Report on Eight Cities)
- 91 The Effects of the Ten Thousand Pound Bomb on Japanese Targets (a Report on Nine Incidents)
- 92 Effects of the Atomic Bomb on Hiroshima, Japan
- 93 Effects of the Atomic Bomb on Nagasaki, Japan
- 94 Effects of the Four Thousand Pound Bomb on Japanese Targets (a Report on Five Incidents)
- 95 Effects of Two Thousand, One Thousand, and Five Hundred Pound Bombs on Japanese Targets (a Report on Eight Incidents)
- 96 A Report on Physical Damage in Japan (Summary Report)

G-2 Division

- 97 Japanese Military and Naval Intelligence
- 98 Evaluation of Photographic Intelligence in the Japanese Homeland, Part I, *Comprehensive Report*
- 99 Evaluation of Photographic Intelligence in the Japanese Homeland, Part II, *Airfields*
- 100 Evaluation of Photographic Intelligence in the Japanese Homeland, Part III, *Computed Bomb Plotting*
- 101 Evaluation of Photographic Intelligence in the Japanese Homeland, Part IV, *Urban Area Analysis*
- 102 Evaluation of Photographic Intelligence in the Japanese Homeland, Part V, *Camouflage*
- 103 Evaluation of Photographic Intelligence in the Japanese Homeland, Part VI, *Shipping*
- 104 Evaluation of Photographic Intelligence in the Japanese Homeland, Part VII, *Electronics*
- 105 Evaluation of Photographic Intelligence in the Japanese Homeland, Part VIII, *Beach Intelligence*
- *106 Evaluation of Photographic Intelligence in the Japanese Homeland, Part IX, *Artillery*
- *107 Evaluation of Photographic Intelligence in the Japanese Homeland, Part X, *Roads and Railroads*
- 108 Evaluation of Photographic Intelligence in the Japanese Homeland, Part XI, *Industrial Analysis*

Faint, illegible text on the left page, possibly bleed-through from the reverse side. The text is arranged in several paragraphs and appears to be a formal document or report.

Faint, illegible text on the right page, possibly bleed-through from the reverse side. The text is arranged in several paragraphs and appears to be a formal document or report.

